

November 2018

Edition 7.4



BEHAVIORAL HEALTH DESIGN GUIDE

Formerly:

Design Guide for the Built Environment
of Behavioral Health Facilities



James M. Hunt, AIA

David M. Sine, DrBE, CSP, ARM, CPHRM

*Includes REVISED
Patient Safety Risk Assessment Tool
to align with The Joint Commission's
November 2017 Recommendations*

Behavioral Health Facility Consulting, **LLC**

Previously Published by:
National Association of Psychiatric Health Systems (NAPHS) 2003-2014
Facility Guidelines Institute (FGI) 2015-2017

CONTENTS

- Introduction 5
- A Word from the Authors 6
- Share Your Bright Ideas 7
- Acknowledgments 7
- A Word from BHFC..... 8
- General Comments
 - 1. Space Planning Considerations..... 9
 - 2. Safety 11
 - 3. Outdoor Areas 14
- Construction and Materials Considerations
 - Level I. Staff and Service Areas 16
 - Level II. Corridors, Counseling Rooms, and Interview Rooms 16
 - Level III. Lounges and Activity Rooms..... 29
 - Level IV-a. Patient Rooms 31
 - Level IV-b. Patient Toilets..... 41
 - Level V-a. Admissions 49
 - Level V-b. Seclusion Rooms 50
- Summary..... 53
- Appendix 54
- About the Authors 138
- Definitions/Resources 139
- List of Manufacturers..... 140

The hospital plans activities to minimize risks in the environment of care.

Risks are inherent in the environment because of the types of care provided and the equipment and materials needed to provide that care. The best way to manage these risks is through a systematic approach that involves proactive evaluation of the harm that could occur. By identifying one or more individuals to coordinate and manage risk assessment and reduction activities—and to intervene when conditions immediately threaten life and health—organizations can be more confident that they have minimized the potential for harm.

The hospital manages safety and security risks.

Beginning in March 2017, the Joint Commission is emphasizing assessment of ligature, suicide, and self-harm observations in psychiatric hospitals and inpatient psychiatric patient areas in general hospitals. A March 1, 2017, [Joint Commission Online article](#) details specific steps surveyors will take during on-site surveys to document all observations of ligature or self-harm risks in the environment. Each observation of a ligature or self-harm risk will be considered a requirement for improvement (RFI).

Joint Commission Online

March 1, 2017

“Listen to the patients; they’ll tell you what you need to know.”

J.J., Safety Officer

Greystone Park State Psychiatric Hospital

New Jersey

Behavioral Health Design Guide

Edition 7.4

November 2018

© 2018 Behavioral Health Facility Consulting, LLC

In an effort to keep up with the rapid increase in the number of products available for use in behavioral health facilities, this document will be updated frequently. The date of each edition is on the cover and at the bottom of each page of the document.

Readers are urged to check: www.bhfcllc.com

whenever referring to this document to assure the latest information is being accessed.

EDITION 7.4

This edition has been heavily revised and edited since the last edition. Therefore, text that has been revised since the last edition is shown in **blue**, as has been our practice in the past.

INTRODUCTION

This document is intended to address the built environment of the general adult inpatient behavioral health care unit. Additional considerations that are *not* addressed here are required for child and adolescent patients, patients with medical care needs, dementia patients, and some patients with diagnoses such as substance abuse and eating disorders.

This document is not a replacement for regulatory requirements, but rather augments them to detail practical means of protecting patients and staff. It is intended to represent best current practices, in the opinion of the authors. It is not intended to represent minimum acceptable conditions and should not be interpreted as establishing a legal “standard of care” that facilities are required to follow.

PLEASE NOTE:

Product information included in this document is intended for illustration of one or more specific items that are deemed appropriate for use in this type of facility. Comparable products by other manufacturers that meet the same design criteria may be substituted after careful comparison.

A WORD FROM THE AUTHORS

The *Design Guide* continues to be based on our experiences in the field as operators, designers, consultants, and surveyors. Our goal is to share what we have seen that is working and what we have seen that has not worked. Since the document was first electronically published by the National Association of Psychiatric Health Systems (NAPHS) in 2003, we have received and welcomed countless suggestions, recommendations, and comments from users of the *Design Guide*, which continue to inform and lead us to new discoveries. We are grateful and humbled by how well our suggestions have been received and that they have inspired others to think of new solutions to the inherent challenges of the behavioral health, built environment.

We hope this edition of the *Behavioral Health Design Guide* (formerly the *Design Guide for the Built Environment of Behavioral Health Facilities*) will meet the expectations of and prove useful to the designers, operators, and clinicians who are entrusted with both the care of behavioral health patients and with the environment of care in which those people are cared for and treated.

As always, we introduce this edition with the same reminder we used to introduce the inaugural edition in 2003: “While a safe environment is critical, no environment of care can be totally safe and free of risk. No built environment—no matter how well designed and constructed—can be relied upon as an absolute preventive measure. Staff awareness of their environment, the latent risks of that environment, and the behavioral characteristics and needs of the patients served in that environment are absolute necessities. We also know that different organizations and different patient populations will require greater or lesser tolerance for risk; an environment for one patient population will not be appropriate for another. Each organization should continually visit and revisit their tolerance for risk and changes in the dynamics of the patient population served.”

As in earlier editions, we have highlighted products we have found to be both safe and able to withstand the rigors of use in the behavioral health care environment. However, inclusion or exclusion of a product does not indicate endorsement or disapproval of that product, nor does it suggest that any product we identify is free of risk. As well, there may be equivalent products available; all facilities should continually look to the marketplace to find products that are safer and more cost-effective.

James M. Hunt, AIA
President
Behavioral Health Facility Consulting,
Topeka, KS 66605
jim@bhfcllc.com
www.bhfcllc.com



David M. Sine, DrBE, CSP, ARM, CPHRM
President
SafetyLogic Systems
Austin, TX
dsine9@gmail.com
www.safetylogicsystems.com
SafetyLogic Systems

SHARE YOUR BRIGHT IDEAS



A continuing feature in this updated edition is the inclusion of **Bright Ideas**, which are indicated by the graphic shown at the left. These are applications that we have thought of, or that have been suggested by readers, that do not require the use of any specific product, but make use of readily available items in creative ways to improve the safety of behavioral health units. Most of these **Bright Ideas** can be implemented by maintenance staff at nominal cost. We thank those who have contributed these ideas and information on new products. We encourage this kind of input and invite feedback from you, the readers. With your help, this can become a compilation of the best thinking of the industry. We promise to include more of your **Bright Ideas** in the future.

ACKNOWLEDGMENTS

We want to express our appreciation to the following professionals who have shared their insight and experience with us and helped make this edition more helpful to other readers:

Larry Denoyer – The Menninger Clinic
Steve Lindquist – Avera McKennan Behavioral Health Services
Tom Hess – Sheppard Pratt Health System
Byron Kitagawa – Sharp Healthcare Corp.
Steve Sullivan – Britton Construction
Tim Rappold – The Good Shepherd Center
Tom Ferrel – Systems West Engineers
Steven Shilts, RN – La Jolla Veterans' Medical Center
Tom Loats – St. Joseph Hospital
Carter Wright – CWC Corporation
Ken Haber – Hackensack Meridian Health

A WORD FROM BHFC

While *The Design Guide for the Built Environment of Behavioral Health Facilities (Design Guide)* addresses the built environment for adult inpatient behavioral health care units and remains co-authored by James M. Hunt, AIA, president of Behavioral Health Facility Consulting, and David M. Sine, DrBE,ARM, CSP, CPHRM, president of SafetyLogic Systems it continues to evolve.

The evolving *Design Guide* has found itself on the move once again as it leaves our friends at the Facilities Guidelines Institute or FGI and now moves to a new home on the Behavioral Health Facility Consulting, LLC (BHFC) website, www.bhfcllc.com. We find this move necessary in order to preserve the independence of the *Design Guide* and, through affiliate relationships, to provide even more organizations and their members access to a document that addresses leading practice design challenges of the built environment for adult inpatient behavioral health care units.

Some of the elements of the *Design Guide* for designing behavioral health facilities, such as the Patient Safety Risk Assessment tool, will continue to appear in the FGI *Guidelines for Design and Construction of Hospitals and Outpatient Facilities*. The *Design Guide* provides much more detail and leading practices for protecting patients and staff as identified through the authors' years of practice in the field. The *Design Guide* is not intended as a replacement for regulatory requirements nor to be employed as a legal "standard of care." Its content is provided to augment the fundamental design requirements for behavioral health facilities and to help providers and design teams develop physical environments that support safe and effective behavioral health services.

As always, we should remind readers that the *Design Guide* does not discuss the additional concerns that must be addressed when designing behavioral health facilities for child and adolescent patients, patients with medical care needs, geriatric patients, or some patients with diagnoses such as substance abuse and eating disorders.

Information is included about products that have been found to be more safe for use in the behavioral health built environment but is in no way a complete list of products available that may be appropriate, while recognizing that no product is entirely without risk. We should also point out that the editors vigorously resist offers to monetize the *Design Guide* or be compensated by enthusiastic vendors.

The *Design Guide* is updated periodically, and while we trust you will find the latest changes helpful, our goal is to provide updates more frequently than has been possible in the past, so please return to these pages occasionally to make sure you are referring to the most current edition.

GENERAL COMMENTS

Space Planning Considerations

- A. **Behavioral health units and facilities should be designed to appear comfortable, attractive, and as residential in character as possible.** The focus on patient and staff safety has often pushed the aesthetics of these units toward the appearance of a prison environment. To better meet the needs of patients, the final design must avoid an “institutional look” while meeting the array of applicable codes and regulations and addressing the therapeutic and safety needs of patients and staff. The challenge is to strike a balance between the safest possible therapeutic environment and a non-institutional appearance that is correct for the unique conditions that exist in each facility.
- B. **Nurse stations should provide the least acceptable barrier between staff and patients.** This goal is sometimes felt to conflict with staff safety concerns as patients may be able to reach or jump over counters, but some facilities have found ways to design nurse stations that protect against these actions without preventing conversation and exchange of objects between staff and patients. HIPAA (Health Insurance Portability and Accountability Act of 1996) privacy regulations can make use of an “open” design challenging because patient records, electronic or otherwise, must be protected from view by other patients, visitors, and unauthorized staff. However, advancements in electronic medical records have somewhat reduced the need to locate all charting-related activities and spaces in the area behind the nurse station. Since the electronic “chart” can be accessed from many locations, the area around the nurse station can often be used for more patient-centered activities. When a more open nurse station is achieved, other areas where clinical staff can discuss patients without being overheard and appropriately secure storage for charts and patients’ valuables are needed.
- C. **Location of gathering areas for patients near the nurse station is encouraged because patients often congregate by the nurse station to socialize.** It is far better to plan for this behavior and accommodate it in the original design. Such gathering areas should include comfortable seating and places for conversation, card or board games, and other quiet activities that will not distract staff working in the nurse station. Television sets, CD players, etc. should not be included at these locations.

Many facilities are now experiencing issues, especially with younger patient populations, regarding use of personal electronic devices (e.g., iPods, MP-3 players, and similar devices). Patients say these electronics help keep them calm, but the wires on the earphones can be hazardous. The decision about how to handle this potential hazard is just one of many decisions that behavioral health

organizations need to weigh to determine the level of risk they are willing to accept for the perceived benefit. It should always be remembered that a patient who has been assessed as safe to use a player may set it down where another patient may pick it up to gain access to the wires.

- D. **Chart rooms and other staff areas should be located so staff members can have conversations regarding patients and other clinical matters without being overheard by patients or visitors.** Teaching hospitals that have a large number of residents and/or students making rounds will need larger spaces for confidential conversations. The expanded use of electronic medical record technology is continuing to change the needs and configurations of these spaces.
- E. **Facilities for medication distribution should support the organization's practices but allow for flexibility.** Medication management has evolved over the years from patients lining up at a window at designated times to staff taking medications to patients wherever they are on the unit. While the trend is strongly toward the latter, some facilities prefer the former or some variation of the two. [This practice should be clearly defined in every facility's functional program and safety risk assessment. Flexibility should be designed into the built environment to allow for future changes in how this critical function is provided. Medication rooms and/or zones should also be provided in accordance with the requirements of the FGI *Guidelines for Design and Construction of Hospitals*, 2018 edition and all other applicable codes, standards and regulations.](#)
- F. Where possible, **locate service areas (such as trash rooms and clean and soiled utility rooms) so they are accessible from both the unit and a service corridor.** This eliminates the need for environmental staff servicing these rooms to enter the treatment areas of the unit and possibly disturb patient activities. All doors to these rooms must be kept locked at all times.
- G. **Traditional nurse call systems for patients to request assistance from nursing staff are not required** in behavioral health units. Significant new developments in duress alarm systems greatly improve safety for staff who find themselves threatened by patients. Sensors located in all patient-accessible areas are activated using a small device that the staff members wear.⁶⁵⁰ Staff activate the alarm when they feel threatened and want other staff to come. Different alarm products announce in different ways, but many provide the exact location of the staff member activating the alarm.
- H. **All electrical outlets in patient rooms should be tamper-resistant, hospital-grade units on ground-fault interrupted circuits.** The breakers for these circuits should be located so staff can easily access them without entering patient rooms. This is easy to accomplish in new construction but can be very difficult to achieve in remodeling projects. If receptacles with individual reset buttons are provided, they should be wired so that activation of one receptacle's breaker does not deactivate the entire circuit.

- I. **All electrical circuits with receptacles near water sources (e.g., sinks, lavatories, and toilets) must be protected by ground-fault circuit interrupted (GFCI) breakers.**
- J. Where possible, **locate water shut-off valves for patient accessible bathrooms in corridor walls so they can be accessed from the corridor by opening a locked access door.** This has been successfully accomplished during remodeling projects of existing units.
- K. Where possible, **locate serviceable parts of patient room HVAC systems where they can be serviced without entering the room.** In new construction, consideration may be given to radiant heating and cooling systems that greatly reduce the need for mechanical devices in patient rooms.
- L. **Housekeeping rooms should be large enough to lock away carts when not in use.** All cleaning materials must be locked inside these carts at all times when carts are in patient areas or corridors and not attended by staff.
- M. **Smoking areas (if provided) should be outdoors.** Furniture should be securely anchored in place. Provision should be made for staff observation without having to breathe secondhand smoke. No wastebaskets should be allowed in these areas. Indoor smoking is not permitted in most facilities, and many hospitals have gone to smoke-free campuses.
- N. At the time of this writing, **the applicable standards** (the FGI *Guidelines for Design and Construction of Hospitals and Outpatient Facilities*, 2018 edition, published by the Facility Guidelines Institute) **require 100 net usable square feet per private patient room and 80 net usable square feet per patient in semi-private rooms (Section 2.5-2.2.2.2).** All requirements of the FGI *Guidelines*, NFPA 101: *Life Safety Code*® (2012 edition), and the Joint Commission standards as well as state and local regulations and building codes must be incorporated into project planning.

2. Safety

The level of concern for how the design of the built environment affects the safety of patients and staff is not the same in all parts of a behavioral health unit or facility. The level of precautions necessary depends on the staff's knowledge of the patient's intentions regarding self-harm and the amount of supervision the patient will have while using that part of the facility. Previous editions of this *Design Guide* have proposed that the level of concern for patient safety in the behavioral health built environment can be stratified into five categories (with five being the highest level of concern). The concept is that some latitude in design, construction, and materials used could be allowed for the lowest level (Level I), described as spaces having no patient access or spaces where patients are under constant supervision (e.g., staff and service areas). Much stricter requirements would need to be met for Level IV, described as an area where patients with unknown or unassessed risks are present or an area in which highly agitated patients could be cared for. Level V areas are those that present special considerations that need to be addressed individually. The concept of this level system

has been confirmed by independent and peer-reviewed research (Bayramzadeh, S, *Health Environments Research & Design Journal* 2017, Vol.10(2) 66-80).

Many have adopted this approach of assessing levels of concern based on a functional statement of intended use and have agreed on the level of risk for rooms or spaces with similar occupant functions (e.g., admissions rooms, examination rooms, etc.). However, caution is necessary as some rooms or room functions can fit comfortably into more than one category or sit on a blurry boundary between two categories. As well, the categories do not anticipate every use of every room. This blurriness can result in clinical staff and facility designers basing design choices on assumptions about the use of a room and its corresponding level of concern that may not meet the actual needs of the stakeholders in an operating environment. For example, a day room may be located within the sight line of a nurse station that “always has staff present.” However, if a patient who can’t sleep is in the day room watching television at 2 a.m. and the only staff member on duty is making rounds, the patient may be “completely alone” for a period of time in a space that may contain hazards.

The authors of the *Design Guide* propose use of a patient safety risk assessment (PSRA) to facilitate conversation between clinical staff and designers regarding patient safety. The PSRA uses a Cartesian matrix to relate an opportunity for a patient to be alone in a space on one axis to a level of risk of self-harm on the other axis. The greater the opportunity for a patient to be alone, the greater the opportunity for self-harm and the greater the caution that should be taken regarding design choices and materials.

Although patient intent for self-harm is often opaque and difficult to assess, in the matrix we have placed “actively suicidal” on the far end of the scale and describe the opposite end as “self-harm not anticipated.” Privacy ranges from close observation (such as “1:1 observation”) on one end of the opportunity scale and the patient “completely alone” on the opposite end.

This risk matrix is informed by Veterans Health Administration longitudinal studies that have identified frequent locations of acts of self-harm by inpatients, Joint Commission data, and Richard Prouty’s seminal work on risk maps. Designers and clinicians, rather than seeking agreement on what is meant by the name of a room, may now seek to agree on the actual or anticipated degree of aloneness or privacy a patient will experience in a room or space (independent of its name), and it is that agreement that will drive design choices for the room or space.

For example, a patient bathroom in which the patient is anticipated to be alone and have privacy would be far along the privacy axis. If that assessment intersects far along the patient intent for self-harm axis, the space should be designed with the attributes of a Level IV space as described in this document. In sum, no matter the name of the room, a high level of privacy warrants a high level of concern if it is anticipated that patients who are actively suicidal (or patients with an unknown or unassessed intent for
(continued on page 14)

HUNT / SINE
PATIENT SAFETY RISK ASSESSMENT

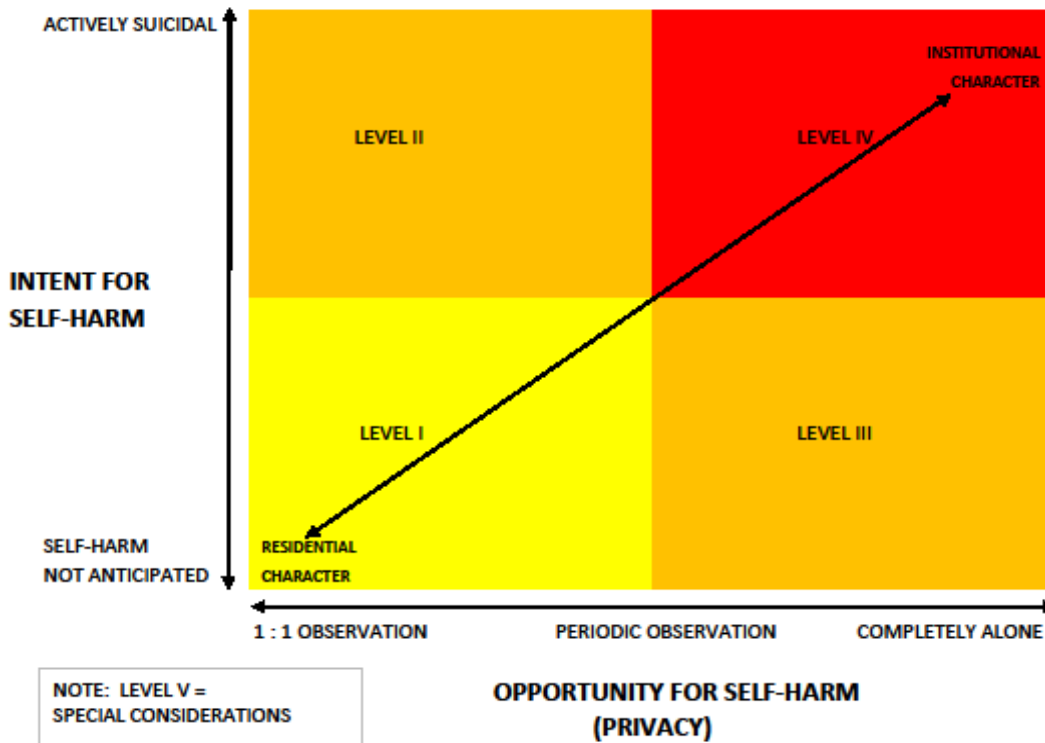

Level I: Areas where patients are not allowed or are under constant supervision, such as staff and service areas.

Level II: Areas behind *lockable* doors where patients are highly supervised and not left alone such as counseling rooms, activity rooms, interview rooms and corridors that are fully visible and do not contain objects that patients can use for climbing.

Level III: Areas that are *not behind lockable* doors where patients may spend time with minimal supervision such as lounges, day-rooms and corridors that are not fully visible. *Open nurse stations should to be considered under this Level.*

Level IV: Areas where patients spend a great deal of time alone with minimal or no supervision, such as patient rooms (semi-private and private) and patient toilets.

Level V: Areas where staff interact with newly admitted patients who present potential unknown risks or where patients may be in highly agitated condition. Due to these conditions, these areas fall outside the parameters of the risk map and require special considerations for patient (and staff) safety. Such areas include seclusion rooms, examination rooms, and admission rooms.

(continued from page 12) self-harm) are to be treated or housed in that space. While different products may be used for spaces with risk assessments located in the Level IV quadrant of the risk matrix than for spaces in the Level II quadrant, the higher risk locations do not necessarily need to look more “institutional.”

The authors believe the use of a tool such as the patient safety risk assessment matrix will facilitate necessary conversations regarding patient safety and design between operators, clinicians, and designers. However, the tool is not intended to predict risk levels in a facility, which the authors believe to be dynamic and non-static. Rather, it is intended to encourage dialog and promote a common understanding of the patients a designed space is intended for and the risks of that anticipated patient population.

Also note that use of the matrix should not be interpreted as a suggestion that patient privacy is not important or is a risk to be avoided. On the contrary, privacy is generally considered desirable in the behavioral health built environment, although it is associated with a risk that should be considered and mitigated through good design where possible.

3. Outdoor Areas

Outdoor areas (e.g., enclosed courtyards, fenced areas adjacent to a treatment unit, or an open campus) are considered to have great therapeutic benefit. Because levels of staff supervision for patients using outdoor areas may vary widely between facilities, or even between different groups using the same space at different times, the need for supervision should be carefully reviewed by management early in a design and construction project. The final design for outdoor areas must respond to the acuity and assessment of the most acute patients using the area.

In all cases, careful consideration should be given to exterior landscaping and furniture used by patients. Trees should be located away from buildings, walls and fences to reduce ease of access to roofs or getting over fences. Climbable fences can permit, if not encourage, unauthorized access to windows and roofs or elopement over walls. Shrubbery should be non-toxic and low-growing. Avoid planting shrubbery close together as it can create visual barriers that patients or unauthorized visitors may hide behind. Landscape mulch or decorative rocks that can be thrown to injure staff or other patients should not be used.

All outdoor furniture⁶⁶⁰ should be firmly anchored in place. This will prevent the furniture from being moved to create barricades or stacked to allow climbing over fences, into windows, or onto buildings. Many types of commercially available furniture can be anchored or are made of concrete or other heavy materials.

Buildings, walls, or fences may be used to establish clear boundaries and impede elopement to a degree appropriate to the patient population being served. Some behavioral health organizations are comfortable with a perimeter enclosure that is not particularly difficult to climb and simply make elopements a treatment issue if the patients return. Other organizations have a very high need to reduce elopements to the extent possible. Where this is the case, the enclosures may take on a very prison-like

appearance. If views to the distance are not required, one approach is to treat the outdoor areas as meditation gardens with solid masonry walls that have a smooth interior surface and are 12 to 14 feet high.

One facility installed large diameter (22"-24") plastic pipe on top of the wall to make it difficult for patients to get a grip on the top surface. This pipe can be painted to match the color scheme of the building and provides a much less institutional appearance than concertina wire. If views to the distance are desired, "windows" glazed with polycarbonate²⁰¹ or security glass²⁰⁰ may be provided in these walls. These view panels should not have sills or cross bars that could provide footholds for climbing.



Another option is installation of a fine mesh chain-link fence fabric.⁶⁷⁵ This fabric, which comes in a range of sizes down to as small as 3/8" openings, makes the fence more difficult to climb and has openings that are too small for most bolt cutters. When installing such material, fence posts and rails must be strong enough to support the fabric and the wind loading it will add. In at least one instance, a patient successfully climbed a mini-mesh fence, so it is suggested a section at the top be angled inward to further increase the difficulty of climbing at the cost of increasing institutional appearance.

Maximum security fencing,⁶⁷⁶ which has a very prison-like appearance, may be selected for some facilities with involuntarily admitted patients. However, use of less institutional-looking solutions should be explored before deciding to use this material.

Where portions of the building walls will enclose exterior courtyards for patient use, these walls should not be easily climbable, especially if they are only one story high. Window sills, rain gutters, and similar features may support efforts to climb walls to gain access to the roof. The exterior surface of all windows patients can access from exterior courtyards must have security glazing,²⁰⁰ polycarbonate glazing,²⁰¹ or security window film,¹⁹⁰ as described under Level II-D.

All areas surrounding patient use buildings, areas where staff will walk or escort patients at night, and courtyards should be well-lighted. Exterior lights should not shine directly into patient room windows.

Parking areas for staff and visitors should be well-lighted and reviewed regularly for design features that encourage personal and property security. While security is generally beyond the intended scope of this document, closed-circuit television monitoring and video surveillance recording of these semi-public areas, where there is no expectation of privacy, should be considered.

All manhole covers, access panels, and area drain grates should be anchored firmly in place to discourage easy removal and use as weapons and to make it difficult for patients to enter the underground piping.

CONSTRUCTION AND MATERIALS CONSIDERATIONS

Each level of concern in the patient safety risk assessment matrix requires increased attention to the built environment to reduce the potential for patients harming themselves or others. The levels are cumulative, and all steps taken for lower levels are also required for the next higher level. For example, all steps recommended for Levels I, II, and III are also recommended for Level IV.

Level I. Staff and Service Areas

Comply with all applicable codes and regulations. All unattended service areas should be locked at all times to reduce the possibility of patients entering these spaces.

Level II. Corridors, Counseling Rooms, and Interview Rooms

Minimize blind spots in corridors where patients cannot be observed from an attended nurse station. All unattended counseling and interview rooms should be locked at all times to reduce the possibility of patients entering these areas. Counseling rooms and interview rooms should have a “classroom”-type lockset that requires a key to lock or unlock the outer handle, but the inside handle is always free.

- A. **Floors** – Carpet²⁵⁵ or sheet vinyl²⁴⁵ meeting class A rating should be used. Avoid patterns and color combinations that may appear to “animate” into objects that could contribute to visual misperception by patients of objects that must be avoided or stepped over. Anti-microbial carpet with solution-dyed yarn and moisture-resistant backing generally works well in these facilities and is available from most major carpet companies.
- B. **Walls** – Abrasion-resistant and impact-resistant gypsum board^{230, 231} hung on 20-gauge or heavier metal studs spaced no more than 16 inches on center is typically considered minimum construction for these areas. Sound-deadening gypsum board²³² is available to help reduce noise levels from traditional hard services. Consult manufacturers regarding the characteristics of the material determined most appropriate for a particular installation. These products are available from several manufacturers.

A painted finish is preferred because it is easy to repair and the cost of renewing or changing colors to keep up with current trends is relatively low. Also, painted finishes help create a residential or home-like ambience while still meeting institutional requirements.

- C. **Ceiling** – A solid ceiling is preferred for all areas of a behavioral health facility. However, where accessibility to mechanical, electrical, and communication equipment is needed, [The Joint Commission’s \(November 2017 Edition of](#)

Perspectives) currently allows a lay-in ceiling to be used under certain circumstances. As of this writing, the authors are not aware of any manufacturer who produces hold-down-clips that are specifically recommended for use to limit patient access above the ceiling. Systems relying on hold-down clips always rely on the last tile being placed is not secure unless some form of locked access panel is provided to allow installation of the clip on the last tile.

Several solutions that can use the existing ceiling grid system and may be less expensive than typical gypsum board ceiling installation may be considered:

1. Remove existing ceiling tile and install specialty 2'x2' metal ceiling panels²³⁷ with tamper resistant screws in the recessed joints to resist removal. This system will allow access at any point and is available in sound absorbing models.
2. Remove existing ceiling tile and install special clips²³⁸ that are made to fit over existing grid members that are at least intermediate grade steel system (not aluminum). Then attach 5/8" thick sound absorbing gypsum board ceiling (mud and tape joints – paint) to these clips. Access panels will be required at all necessary locations. It may be necessary to support light fixtures, etc. independent of the existing grid to avoid overloading the carrying capacity of the existing grid.

- D. **Glazing** (Interior and Exterior) – When it is broken, all glazing that is exposed in patient-accessible areas should stay in the frame and not yield sharp shards that patients could use as weapons. Terminology can be confusing in that laminated glass like that used in vehicle windows is often referred to as “safety glass” but, when broken, can yield large sharp pieces. All glazing materials that are exposed in all patient accessible areas should be considered, including the exterior surface of windows accessible from exterior courtyards to be used by patients.

Some of the forms of glazing recommended for use in behavioral health facilities are listed here:

1. **Standards** – All glazing in patient-accessible areas should be safety glass.

The 2018 edition of the FGI *Guidelines for Design and Construction of Hospitals* contains the following reference to window testing:

2.5-7.2.2.5 Windows...

- (2) *To prevent opportunities for suicide, self-harm, and escape, the entire window system and the anchorage for windows and window assemblies, including frames and glazing, shall be:*
 - (a) *Designed to resist impact loads of 2,000 foot-pounds applied from the inside*
 - (b) *Tested in accordance with AAMA 501.8-13: Standard Test Method for Determination of Resistance to Human Impact of Window Systems*

Intended for Use in Psychiatric Applications. Where operable windows are used, hinges and locking devices shall also be tested.

2. **Impact-Resistant Glass Products** – Several glass manufacturers²⁰⁰ offer products that may be appropriate for use in behavioral health facilities. The products chosen will vary depending on the size of the opening, type of frame, patient population being served, and location of the glazing in the unit (as determined by the patient safety risk assessment) including the distance the opening is above grade. We suggest contacting manufacturers directly to determine which products may be appropriate for a specific project.
- a. **Heat-Strengthened Glass** – Although more difficult to break than regular float glass, heat-strengthened glass has about half the strength of tempered glass. Heat-strengthened glass may be a good choice if it is laminated and high-impact resistance is not required for the location.
 - b. **Tempered Glass** – This may be acceptable for use in some patient-accessible areas such as small windows in doors, portions of glass walls separating activity rooms from corridors, and patient toilet room mirrors. Tempered glass is more impact-resistant than float glass or laminated glass but will break into many small pieces and fall out of the frame, which may allow a patient to elope. As well, each piece may have sharp edges. Patients have been known to break tempered glass mirrors and rub the inside of their wrists on the broken surface to cut themselves or swallow the small pieces of glass. This hazard may be reduced by covering the tempered glass with a security film as described below.
 - c. **Tempered/Laminated Glass**²⁰⁰ – Two layers of tempered glass are bonded to a PVB interlayer, which helps the glass stay in the frame when broken.
 - d. **Glass-Clad Polycarbonate Glazing**²⁰⁰ – Two layers of heat-strengthened glass are bonded to a polycarbonate core. This combination keeps the broken material in the frame and reduces patient access to shards of glass that could be used as weapons and is usually available in 7/16" and 9/16" thicknesses.
 - e. **Window Film** – If replacing existing glass is cost-prohibitive, applying a window film security laminate¹⁹⁰ to existing glass may be an alternative. Although these films are susceptible to scratching and defacement by patients, they may be removed and replaced at less cost than replacing glass or polycarbonate panels. The manufacturer's installation instructions should always be carefully followed including any impact-protection adhesives and a perimeter attachment system needed to hold the glass in the frame if broken. In our opinion, claims that these window films will prevent glass from breaking should not be relied upon.
 - f. **Wire Glass** – This will break and yield sharp shards of glass and is generally not permitted by many current codes and regulations. Any use of wire glass

should be verified with all authorities having jurisdiction as many codes have placed restrictions on its use.

- g. **Fire-Rated Glass**²⁰⁵ – Clear fire-rated glass products are now available in a variety of types and ratings and some are rated for impact resistance.
- h. **Polycarbonate**²⁰¹ (Lexan) – Polycarbonate panels are highly impact-resistant and available in a variety of thicknesses from several manufacturers. These products will deflect upon significant impact near the center of large panels that can result in large pieces coming out of their frames. Care should be taken to assure that the depth of the stop securing the panel will be able to hold it when subjected to this and other impacts. This material is also highly susceptible to scratching and is a frequent target of patients who write profanity and draw pictures. Mar-resistant coatings are available, but they do not eliminate this concern. Recent projects have indicated this may be the more expensive than glass-clad polycarbonate products.

E. Doors

- 1. **Elopement Buffers** (formerly called sally ports) – The FGI *Guidelines* calls for the “*primary access point to the locked unit to be through a sally port*” (Section 2.5-2.2.1). A sally port has two doors (or two sets of cross-corridor doors) that are spaced far enough apart for a gurney to be between the electrically interlocked doors. This system requires that the first door is closed and locked before the second door is allowed to unlock.

2. Access Control –

- a. Provide intercom (or telephone) for communication to nurse stations from outside the unit if needed.
- b. Electronically controlled access systems are preferred. These may be operated by a switch at the nurse station if the door is clearly visible from the location of the release button. (Care should be taken to assure that patients are not in the area when the door is released.) Card readers or keypads adjacent to the door are also commonly used. These are readily available from hardware suppliers and are generally extensions of systems already in place at the facility.

- c. **Metal Detectors** – Some organizations have expressed the desire to use metal detectors to assist with screening patients and/or visitors to their behavioral health facilities. Some choose to use hand-held detectors and others use standard walk-through detectors. Organizations considering metal detection solutions may want to investigate ferrous metal detection systems⁶⁶⁰ that sense the presence of ferrous metal in objects such as razor blades, syringes, lighters, cell phones, knives and guns. These systems will not detect drugs or other nonferrous metal contraband items.



3. **Cross-Corridor Doors** – These doors are provided for several reasons, and each has its own unique function and requirements. Some are part of code required fire rated partitions and normally held open and others are to restrict patient or public access and normally locked and to automatically unlock when the fire alarm is activated (fail safe operation) or remain locked when the fire alarm is activated (fail secure operation). When there is concern that electromagnetic locks may not be sufficient to hold these doors when impacted by patients, concealed deadbolts with the electric release in the lever handle¹⁰⁹ or electric strikes (for single doors) may be provided.

4. **Other Doors** – Doors in behavioral health facilities are subject to heavy use and possibly extensive abuse. They make up a significant percentage of the exposed wall surface in corridors and thus have a strong visual impact on these spaces.

Painted steel doors are durable, easily touched up or refinished, but more institutional in appearance. Doors with wood veneer faces and stain and varnish finish are more “residential” in character but are easily damaged and difficult to repair. Plastic laminate covered doors are also easy to chip on the edges and may soon become unsightly. One way to address the damage these doors receive is to add stainless steel kickplates, door edges, and other add-on devices, although these add to an institutional look. (NOTE: The installation of kickplates may invalidate the fire rating of doors in some jurisdictions.) Kickplates and other protective devices are also available in durable synthetic materials that come in a variety of colors, which soften the stainless-steel look but can still result in a patchwork appearance.

A possible solution to these issues is doors faced with a durable synthetic that has a wood grain appearance. Some of these doors have removable end caps,^{25a} which can be replaced if they become damaged at much less expense than replacing the entire door. Doors with synthetic faces without the replaceable end caps^{25b} are available for a lower initial cost.

Although the first cost for these synthetic-faced doors is higher than for doors of other materials, they do not require the added expense of finishing the doors and purchasing and installing kickplates, etc. Thus, the life cycle cost can potentially be much less than for other doors, and the appearance over time may be a significant improvement.



F. Hardware

1. **Hinges** – Geared-type continuous hinges are preferred for all doors patients will pass through and normally locked doors that have hinges exposed in patient accessible areas because they minimize possible attachment points. These hinges are available from various manufacturers with a closed-sloped top and continuous gears that resist ligature attachment.¹¹¹ Field cutting the top of hinges to create this slope is strongly discouraged because that often exposes voids that may be used as ligature attachment points.
2. **Closers** – Closers are generally not required for patient room doors in most jurisdictions but may be required for other doors. Where needed, concealed closers^{100a} that have the closer and the track both completely contained in the head of the door and frame offer the least amount of ligature attachment opportunity (the arm is only exposed when the door is open). However, these require special preparation of the door and frame and are difficult and expensive to provide in existing conditions. Where concealed closers are not practical, it is suggested that track closers^{100b} be mounted on the corridor side of the door or away from rooms where patients will be alone or in groups.
3. **Locksets** – Use of some type of ligature-resistant lockset is recommended for all doors in patient-accessible areas. A lockset can be used for ligature attachment in three ways: pulling down, pulling up and over the top of the door, and tying something around the latch edge of the door using both the inside and outside handles (transverse). The latchbolt itself has even been used successfully as an attachment point and some companies offer a tapered bolt to help with this. The downside to this is that it makes it easier to open a locked door by using a small piece of cardboard or other item. Also, the opening behind the strike plate can be a ligature attachment point; for this reason, a box should always be provided behind the strike plate. In our opinion, the perfect solution for this dilemma does not exist at this time. Several of the better options are discussed below.
 - a. Locksets with a Lever Handle¹³⁰ – These effectively deal with up and down pressure but are susceptible to transverse attachment. The lever should move freely in both directions when locked to reduce ligature attachment risks. This type of handle is more typical (less institutional) in appearance and operation than other choices. Both of these qualities are very desirable in

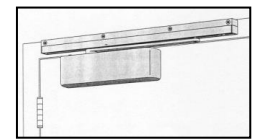
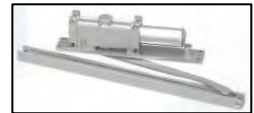
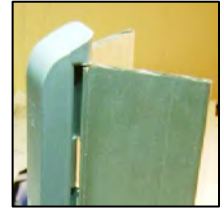

items that patients will touch and use on a regular basis. However, lever handles may present more risk than some of the other choices.

- b. Crescent Handle Lockset¹³⁶ – This type of lockset has a lever handle and thumb turn that are ligature-resistant and may meet ADA requirements. It is available with a handle that can be mounted in a horizontal position and allows the user's hand to easily slip off the free end.



- c. Paddle Handle Locksets¹³⁷ – When installed with both handles pointing down, this type of lockset resists pulling down and, to some extent, transverse attachment. However, it is very easy to pull up on the handle and loop something over the top of the door. This hazard can be reduced by installing an over-the-door alarm as discussed later in this document.



- d. Push/Pull Hardware – This type of door handle is available with a flush push pad on one side and a ligature-resistant pull handle on the other.^{137b}



- e. Modified Lever Handles – These provide minimal ligature attachment risk but have an unusual appearance and operating motion. They are available in various designs.



4. Unit Entrance Door Hardware –

Electronically controlled access systems with electric strikes or electromagnetic locks are preferred. See Level II-E-2 (Doors – Access Control).

The two doors or two sets of cross-corridor doors in an elopement buffer (sally port) are electronically interlocked so that only one door can be open at a time. Care should be taken to assure that adequate space is provided for both doors to be closed at the same time with a gurney in between. Packaged systems for this hardware¹⁴⁴ can be used to satisfy this requirement.

- 5. **Exit Door Hardware** – Exit doors (including stairway doors) in behavioral health facilities are often locked at all times. They may be locked with electromagnetic locks¹¹⁰ connected to the fire alarm system and may stay locked when the fire alarm is activated (fail secure) or release when the alarm is activated (fail safe) as deemed



appropriate for the patient population. The acceptability of this type of hardware and its operating mode should be verified with the local authorities having jurisdiction. Electromagnetic exit door locks are available in varying holding strengths, and the mounting position recommended by the manufacturer must be carefully followed to provide the rated holding force. For extraordinary circumstances, more than one electromagnetic lock can be provided per door or electrically operated deadbolts or a vertical frame member at the strike jamb may be required.

6. Hardware for All Unit Doors

a. Doors for which applicable codes and regulations require a closer but that need to be open to allow staff observation of patients are preferred to be equipped with a hold-open equipped closer that has a built-in release¹⁰¹ that allows the door to close automatically when the fire alarm is activated. **The more standard magnetic hold open devices that are separate items provide ligature attachment risks and are less desirable.**

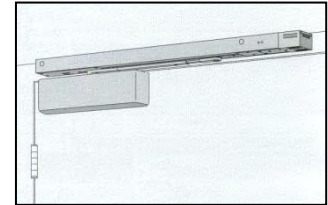

b. For doors that swing into rooms with patients in them, one of the barricade-resistant methods discussed in Level IV-a should be used.

7. **Door Smoke Seals** – These may be required in some situations and are often applied with adhesive strips that can allow patients to remove them to use as ligatures. Smoke seals that break into 8”-long pieces¹⁰ are preferred for use on all doors that patients will pass through. **These are available from several manufacturers.**

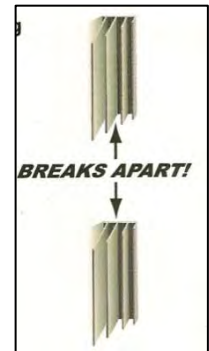

8. **Hardware for Toilet and Shower Rooms** – Patient-accessible toilet rooms and shower rooms located near activity rooms and other locations on the unit should have all the features of the patient toilet rooms discussed in Level IV-b. In addition, they will need to have a “classroom function” locking device to limit both unauthorized use and entrance by others when in use.

G. Light Fixtures – If located at a height or location that is not easily accessible to patients, these may be normal fixtures and lamps as long as staff observation is good from an always attended nurse station and there is no furniture or other items in the area that patients can use to climb on and reach the ceiling. However, tamper-resistant fixtures are always preferred for patient accessible areas of inpatient units or areas where patients are reasonably anticipated to be alone (i.e. Level III of IV). Where fixtures can be reached by patients or in areas that are not readily observable by staff, light fixtures should be a tamper-resistant type⁶²⁰ and have minimum ¼”-thick polycarbonate prismatic lenses⁶³⁴ securely fixed in the frame with covers that are firmly secured with tamper-resistant screws.⁴⁷⁰ Many such fixtures are now available with LED light sources.



Glass components that could be accessed by patients should not be used in any fixture. Use of table lamps or desk lamps is strongly discouraged. Neither incandescent lightbulbs nor fluorescent tubes should ever be accessible to patients.



Motion detector control of corridor light fixtures (other than minimal night-lighting) has been suggested. This would allow staff to know immediately when a patient leaves his or her room.

H. Fire Sprinklers – Institutional heads⁵²¹ that provide very little opportunity for attachment should be provided.



I. HVAC Grilles and Equipment

1. Standard grilles with small perforations⁶⁰⁰ that are secured in place with tamper-resistant fasteners are generally acceptable in corridors, counseling rooms, and interview rooms as long as they are mounted high enough that patients cannot easily reach them.
2. Where existing fan/coil units (as well as fin-tube heaters or old style radiators) are present in these spaces, they should be protected with vandal-resistant covers.⁶⁰⁶



J. Window Coverings

1. **Mini-Blinds** – Mini-blinds mounted between layers of safety glass²⁰⁰ are preferred because the blinds are not accessible to patients. Care should be taken to assure that any exposed devices for controlling the tilt of the blinds do not create a potential ligature attachment point. Some commercially available window assemblies have all these features.⁴³⁰ Exposed mini-blinds should never be used.

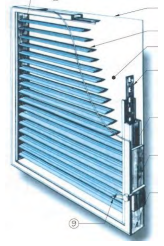

2. **Roller Shades**⁴⁴⁰ – Roller shades specifically manufactured for use in psychiatric hospitals are another option. These have enclosed security roller boxes, security fasteners, cordless operation, and locking devices that resist tampering by patients may be acceptable for some patient populations. If access to these blinds by patients is deemed not acceptable, electrically operated standard roller blinds may be installed behind security glazing.



3. **Electrically Obscured Glazing**²²¹ is becoming more reasonably priced and may be a good option for controlling privacy.

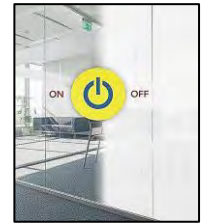

4. **Curtains and Curtain Tracks** – Curtains and associated tracks of any type (including those designated as “breakaway” and represented by their manufacturers as “safe for psychiatric hospitals”) are not recommended for use in any patient-accessible areas, especially patient rooms and patient showers.

- K. **Operable Windows** – Windows in all patient-accessible areas should comply with all applicable codes and regulations for operable sash. Where operable windows are provided, they should be equipped with sash control devices¹⁷⁰ that limit how far the window can be opened and that, where required, can be released to full opening using a key for evacuation purposes. Window systems are also available that allow fresh air⁴³⁴ through a rotating vent at the bottom or by sliding the window open a few inches.



L. Miscellaneous

1. **Trash Can Liners** – Plastic trash can liners should not be allowed in any space accessible to patients. Breathable paper liners¹ should be provided.
2. **Telephones** – Telephones located in corridors or common spaces for patient use should have a stainless-steel case,⁶⁵⁵ be securely mounted to the wall, and have a non-removable shielded cord of minimal length **with cable tether inside the shield**. They may be equipped with or without touch pads for placing outbound calls.
3. **Cabinet Pulls** – These should be recessed, with no protruding openings, or of a closed ligature-resistant type.⁴⁶⁰
4. **Cabinet Locks** – These are very important in all patient-accessible areas. Cabinets used to store items that patients could use to harm themselves or others should be kept locked at all times when patients are present. This can lead to staff constantly looking for the right key on a large keychain. One solution is to provide locks that can be unlocked with a key that staff already carry, such as the key used to activate the fire alarm. Another solution is to use existing key access cards or a pushbutton keypad.⁴⁶⁵ These are becoming more affordable and should be particularly helpful in examination/treatment rooms and any locked cabinets in patient rooms.
5. **Room Signs**³⁰⁰ – Room signs are available in a flexible material that is applied with adhesive and will not provide a weapon to patients if removed. These can include braille lettering and meet ADA requirements.
6. **Fire Response Equipment** – All fire alarm pull stations and all fire extinguisher cabinets⁵²¹ should be locked (with approval of all applicable code authorities). All staff on duty must carry keys for these at all times. These keys should be provided with a red plastic ring or other means of providing quick identification. In addition, fire extinguisher cabinets should have continuous hinges, recessed pulls (if any), and polycarbonate glazing if view windows are provided.



7. **Lighted Exit Signs⁶⁴⁰ or Photoluminescent Signs⁶⁴²** –

These should be vandal-resistant and installed tight to the ceiling with a full-length mounting bracket to avoid use as a hanging device. Mounting these signs on a wall so they are perpendicular to the wall is not recommended because it leaves the top exposed as a possible attachment point.



8. **Observation Mirrors** – Convex mirrors installed in corridors, seclusion rooms, and other patient-accessible locations to assist with observation of patients should be made of a polycarbonate that is a minimum of 1/4" thick, be filled with high-density foam, and have a heavy metal frame that fits tightly to the wall and ceiling.⁴²⁰ Convex mirrors made of polished steel are also available. The perimeter of the mirror should be sealed with pick-resistant caulking.²⁰



M. Furniture

1. Furniture used in behavioral health facilities should be easily cleaned, easily reupholstered, very sturdy, and as heavy as possible to minimize the likelihood of patients throwing chairs, tables, etc. As much furniture as practical should be built-in or securely anchored in place to prevent stacking or barricading of doors. Remaining loose items (such as chairs) can vary from high-quality wood, steel or plastic. Armed upholstered chairs⁴⁸² that resemble typical residential furniture are generally preferred, but polyethylene rotationally molded⁴⁸³ and sand-ballasted seating is now available with a less institutional look. The health care organization should select furniture appropriate for the patient population served.
2. Lockable storage cabinets and drawers should be provided, along with the means to lock phones and computers away from patients. Some organizations have a switch installed in a staff area to deactivate patient use phones at times when patients are not allowed to make calls.
3. All upholstery and foam used in furniture should have flame-spread ratings that comply with the requirements of Section 10.3 of NFPA 101: *Life Safety Code*®.



N. Pictures and Artwork – All pictures and artwork in patient-accessible areas must be given special consideration:

1. **Murals** – These can brighten and add interest to corridors and day rooms and have been used very effectively in some facilities. It is usually a good idea to cover them with at least two coats of a clear sealer for protection, but patients typically enjoy these and defacing them is not usually a problem. Murals are also available on wall vinyl and wall protection materials.



2. **Wall Protection** – Large sheets of durable wall protection material are available with a wide variety of printed artwork.³⁰⁴ However, the standard vinyl trim pieces that come with this material should not be used for behavioral health applications. Rather, the edges of the material should be tightly fitted together and sealed with pick-resistant caulk.²⁰



3. **Frames** – Specially designed frames³⁰² that slope away from the wall and have polycarbonate²⁰¹ glazing are recommended. The frames should be screwed to the walls with a minimum of one tamper-resistant screw⁴⁷⁰ per side. Care should be taken to reduce opportunities for attaching ligatures to the frame or the joint between the top of the frame and the wall, especially when the surface of the wall is not perfectly flat, causing gaps between the wall and frame. The joint at the top should be sealed with a pick-resistant sealant.²⁰ Some of these frames allow for easy replacement of the images and provide the opportunity for patients to customize the displays with personal photos, etc.

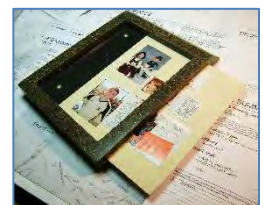

4. **Printed Flexible Vinyl** – Another option is to print artwork on flexible vinyl³⁰¹ that can be attached to walls with low-tack adhesive or regular wall vinyl adhesive for more permanent installations. This method reduces the risk of patients obtaining harmful materials. The low-tack adhesive used on smaller images makes it easier to change the art displayed on a seasonal or other basis and allows hospitals to offer patients a choice of artwork to display in their rooms, giving them some control over their environment.

- O. **Ligature-Resistant Drinking Water Stations** – Drinking fountains are often required or desired in common spaces on units. Typical drinking fountains can prove problematic for ligature and infection control reasons, but requiring patients to ask staff every time they want a drink of water can rank high on patient dissatisfaction surveys.

To address this issue, consider use of water cup-filling stations in patient-accessible areas. Several options are available for cup-filling stations⁵⁸⁹ that have either local or remote refrigeration units, in both wall-mounted and countertop styles.



Level III. Lounges and Activity Rooms

- A. **Floors** – Use sheet vinyl²⁴⁵ where wet or potentially messy activities will be conducted. Carpet should be broadloom or sheet carpeting and have antimicrobial, solution-dyed yarn and non-moisture absorbent backing.²⁵⁵
- B. **Walls** – Same as for corridors in Level II.
- C. **Ceiling** – Non-accessible solid gypsum board ceilings or [secure sound absorbing ceilings that allow accessibility](#) are preferred. If sound attenuation for gypsum board ceilings is desired, either use sound absorbing gypsum board²³² or apply 1’x1’ acoustic tile to the gypsum board. [Ceiling heights lower than nine-foot-high are discouraged because it is easy for patients to reach them and tamper with the ceilings and ceiling-mounted devices.](#) Ceiling heights of nine-feet and above are not immune from tampering and must be evaluated in the Safety Risk Assessment for each unit. [The authors do not recommend that standard \(unsecured\) accessible ceilings be provided in Level III areas. One of the solutions in Level II C above are preferred.](#)
- D. **Glass** – Same as for corridors in Level II.
- E. **Hardware** – Same as for counseling and interview rooms in Level II.
- F. **Light Fixtures** – Same as for corridors in Level II.
- G. **Fire Sprinklers, Institutional Type** – Same as for corridors in Level II.
- H. **HVAC Grilles and Equipment** –
1. Grilles with very small perforations⁶⁰² or grilles with “S” shaped vanes⁶⁰⁰ that comply with National Institute of Corrections standards should be used in Level III spaces.

2. If individual fan/coil-type units exist and must remain, they should be protected with vandal-resistant covers⁶⁰⁶ the same as for corridors in Level II-I.

I. **Window-Covering Hardware** – Same as for counseling and interview rooms in Level II.

J. **Furniture** – All lounge furniture requirements listed for counseling and interview rooms in Level II also apply to this level. Where movable seating is required (e.g., dining and activity rooms), very lightweight polypropylene chairs⁴⁸¹ that resist breaking into sharp pieces are preferred. An alternative is a chair that can be partially filled with sand to make it difficult to throw or use as a weapon.⁴⁸⁰ Comfort Rooms and other lounge areas may have specialty bean bag^{481d} type seating that is manufactured without zippers and with very durable materials and seams.



K. **Kitchen Appliances**

1. All cooking appliances (ranges, microwaves, coffee makers, etc.) should have key-operated lockout switches⁶¹¹ to disable the appliance. **If these and other appliances, such as refrigerators, have open handles that could be used as ligature attachment points, and they are in areas where patients have unsupervised access to them, provisions should be made to close them off with overhead coiling doors or other means.**
2. Patient access to coffee should be carefully considered in each facility's risk management program. If access to this (and other potentially scalding liquids) is allowed, an insulated plastic dispenser should be located so it is readily observable by staff. Glass coffee pots should never be available to patients.
3. All garbage disposal units should have a key-operated lockout switch⁶¹¹ to disable the device.
4. All receptacles located near sources of water, including sinks, as well as all patient-accessible receptacles must be GFCI-protected.

L. Miscellaneous

All miscellaneous requirements listed for counseling and interview rooms in Level II apply to this level also.

1. **Electrical Device Cover Plates** – All electrical device cover plates (for switches, receptacles, etc.) must be attached with tamper-resistant screws.⁴⁷⁰ Cover plates made of polycarbonate⁶¹² materials are preferred; each cover plate must have screws in each corner to make it rigid enough to resist bending and protect patients from access to electrical wiring and contacts. Standard stainless steel cover plates that fit tightly to the wall are rigid enough to be allowed for many patient populations. These may be secured with a single tamper-resistant screw in the center as long as it is securely tightened.

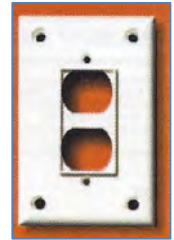

2. **Television** – TV sets should not be mounted on walls using exposed brackets because of the ligature risk this presents. Rather, all TV sets should be installed in built-in TV or media centers or manufactured tamper-resistant covers with sloped tops.²⁹⁰ They should also have an isolation switch that staff can control.



For maximum safety, the electrical outlet and cable TV outlet should be located inside the cover to keep the wires and cables away from patients. One facility utilized unused platform beds mounted vertically on the wall to house television sets and conceal all wires and cables.

Level IV-a. Patient Rooms

- A. **Floors** – Same as lounges and activity rooms in Level III. If some patients are prone to urinate on the floor, provide some rooms with seamless epoxy²⁵⁰ or sheet vinyl flooring with an integral cove base. Metal or plastic strips should not be applied at the top edge of the base.

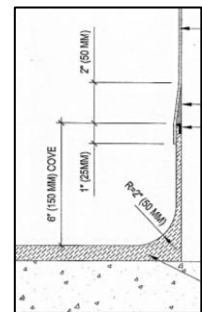

- B. **Walls** – Impact- and/or abrasion-resistant gypsum board²³⁰ installed on minimum 20-gauge metal studs spaced no more than 16 inches on center; paint finish preferred. Sound-attenuating gypsum board²³² may also be used on walls if approved by the manufacturer for use in behavioral health applications.

C. **Ceiling** – Non-accessible solid gypsum board (sound-attenuating if desired), painted. Provide key-lockable access panels⁵⁰ at all patient-accessible locations. If these access panels do not fit tightly or are a larger size, it may be necessary to provide tamper-resistant screws in the corners or along the sides of the panels. **Pick-resistant caulk may be needed if the flanges of these panels do not fit tightly to the ceiling or wall surface.**



D. **Doors** – Patient room-to-corridor doors may present an opportunity for patients to barricade themselves in their rooms to delay staff members' access. One solution is to hinge the door so it swings into the corridor. However, this may create its own problem with the *Life Safety Code* and other building codes. This arrangement may also result in creation of an alcove that is difficult to observe and that patients may use as a hiding place from which to attack staff or other patients.

To avoid these problems, patient room-to-corridor doors may be mounted to swing into patient rooms using several other barricade solutions:

1. Double-acting continuous hinges¹¹³ can be used on patient room-to-corridor doors to counteract barricading without the hazard presented by pivot hinges. These continuous hinges can be paired with full-height emergency stops¹¹⁵ that lock in place and can be easily unlocked to allow the door to swing into the corridor.
2. The door-within-a-door⁴⁴ (sometimes referred to as a “wicket” door) has a portion of the center of the door hinged to swing into the corridor. This hinged panel is mounted on a continuous (or concealed) hinge and secured with a deadbolt lock **that has no visible hardware on the room side of the door. Care should be taken with the detail of the edge of the smaller panel so that a crack is not provided that can be seen through.**

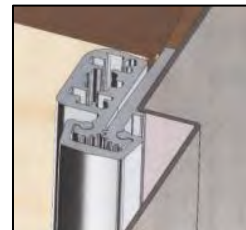
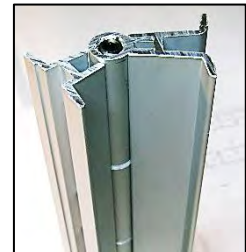

- If space is available, a separate narrow (18"–24" wide) door that swings into the corridor may be used for emergency access to the room. This smaller leaf can either be mounted in the same frame as the main door in a "double-egress" configuration or there can be a mullion⁴⁷ between the two leaves. The mullion provides a more secure, quieter and fewer adjustment issues with the hardware while a wider opening is provided with both leaves open when the mullion is not provided.



- The top of all tight-fitting doors provides a pinch point that allows a patient to tie a knot (in a sheet, the leg of a pair of jeans, or other object), place it over the top of the door, and close the door to create a hanging device. One way to reduce this risk is with a pressure-sensitive or photoelectric device placed near the top of the door that can sound an alarm¹⁵⁰ when activated.

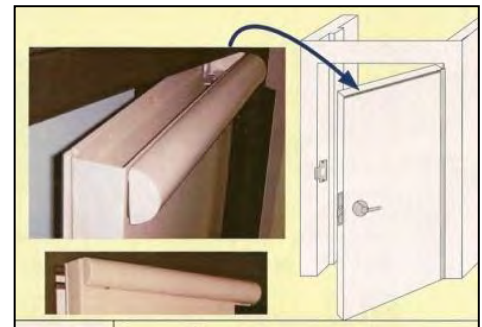
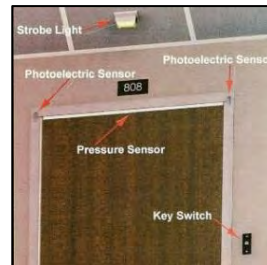

- Some facilities have begun to address the desire of some patients to lock themselves in their rooms to avoid unwanted entrance by other patients. The challenges with this are to provide individual security for the patient without restricting staff access to the room. Options include locksets with specialized locking functions and ligature-resistant turnpieces¹⁴⁰ that cannot be held from inside the door to resist a key being turned to unlock the door. A cylinder protector¹⁴¹ to cover the lock cylinder on the corridor side of the door resists attempts to insert objects in the keyway. Card access technology is also available to control these locks.

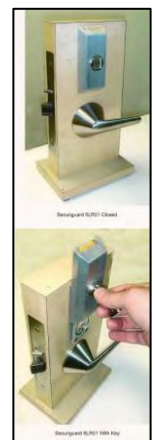

E. Glass

1. **Exterior Windows** – See Level II-D-1 (Safety Glazing) and K. (Operable Windows).

Advances in different types of safety glass make it worthwhile to consult an expert for advice for a specific project. The height above the ground, patient population, and many other factors should be taken into account in choosing these materials. Comply with all applicable codes and regulations for [glazing](#), [frame installation](#) and operable sash.

2. **Security Screens** – If replacing windows presents a prohibitive cost in remodeling work, a security screen with a very sturdy steel frame⁸⁰ designed to resist deflection and equipped with multiple key locks and a heavy-gauge stainless steel screen fabric⁸¹ may be used. These are functional and secure, but create an “institutional” appearance and can be defaced by writing obscene words with toothpaste (or other material). Patients have also been known to use the rough surface of the screen fabric to abrade their skin.

3. **Mirrors** – [There are several options now available.](#)

- a. [Glass-laminated polycarbonate mirrors in ligature resistant wood frames offer an option with a residential appearance and are scratch resistant.](#)

- b. [Polycarbonate mirrors with built-in lighting are attractive and non-institutional but are susceptible to scratching.](#)

- c. Typical radiused stainless steel-framed security mirrors³⁶⁰ are available with polycarbonate, tempered glass, stainless steel, or chrome-plated steel reflective surfaces. Each has different durability and distortion characteristics. Some framed mirrors have a flat surface on top and/or do not fit tightly to the wall and provide opportunities for ligature attachment. Where this occurs, a tapered strip³⁶¹ may be installed to reduce this ligature risk.

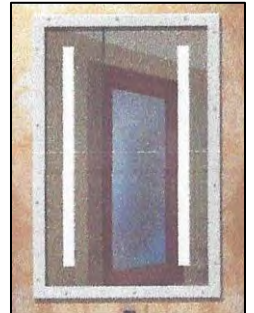

4. **View Windows to Corridors** – Use of polycarbonate,²⁰¹ security glazing, or tempered glass is recommended for view windows to corridors in doors and sidelights. If a fire rating is required by code, fire-rated glass should be provided. Wire glass is no longer allowed by most codes and jurisdictions.

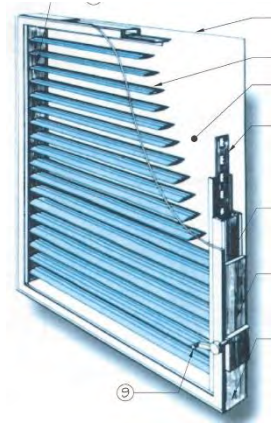

Use of view windows in patient room-to-corridor doors or sidelights brings up some conflicting issues. One point of view is that they are necessary to allow staff observation, while others believe the windows infringe on patient privacy because anyone, including other patients, can see into the room. Possible solutions are to provide an operable blind²²⁰ that only staff can control from the corridor side or glazing that can be electrically obscured.²²¹

F. **Hardware** – See comments under Level II-E.

It is highly desirable to keep vacant patient rooms locked at all times to prevent other patients from entering these rooms without staff knowledge. However, because many jurisdictions do not permit provision of means to lock a patient in a room, “classroom”-type locks are recommended. These can always be opened from the inside, and the corridor side may be either locked or unlocked with a key.



G. **Light Fixtures** – Same as in Level II except that all light fixtures should be security-type fixtures.⁶²⁰

Advancements in LED lighting applications are rapidly creating new options. The use of traditional 2’x4’ fluorescent light fixtures creates a very commercial or institutional appearance in patient rooms, and the placement of one of these directly over the bed is a carryover from general hospital design that is seldom needed in behavioral health facilities. Preference is for using either round or oval surface-mounted, vandal-resistant fixtures for general illumination and recessed security downlights with polycarbonate lenses over the beds for reading lights. Many of these fixtures are now available with LED light sources.



Small individual reading lights⁶²⁴ can be provided to give reading light or allow patients to turn on a small light to assist when getting up in the middle of the night.



Covers⁶³⁰ are available for existing (or new) downlights that are secure and make the appearance more residential in nature.

No glass components should be exposed to patients in any fixture, and use of table lamps and desk lamps is strongly discouraged.



H. Fire Sprinklers, Institutional Type – Same as for corridors in Level II.

I. HVAC Grilles and Equipment

1. Fully recessed vandal-resistant grilles with S-shaped air passageways⁶⁰⁰ are recommended for all ceiling and wall-mounted grilles.
2. In new construction or major remodeling projects, locate individual room HVAC equipment (such as fan/coil units) in an adjacent corridor or another location (e.g., an interstitial space) where they can be serviced without entering the patient room.
3. If individual fan/coil-type units exist and must remain, they should be protected with vandal-resistant covers⁶⁰⁶ the same as for corridors in all other Levels.

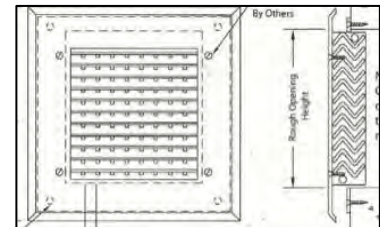

J. Window-Covering Hardware – Same as for counseling and interview rooms in Level II

K. Furniture

1. **Furniture** – Sturdy wood, thermoplastic, or composite furniture should be bolted to the floor or walls whenever possible. Care must be taken to assure the furniture will withstand abuse, will not provide opportunities for hiding contraband, does not have joints that will allow penetration of liquids such as urine, and will resist being disassembled to provide patients with weapons.

Open-front units with fixed shelves and no doors or drawers⁴⁹⁵ are recommended. Doors should not be provided because they can be used by patients to hang themselves. Drawers should not be provided because they can be removed by patients and broken to use as weapons. All upholstery and foam used in furniture and mattresses should have flame-spread ratings that comply



with the requirements of NFPA 101: *Life Safety Code*, Section 10.3.

Desk chairs are preferred to be lightweight⁴⁸¹ or ballasted⁴⁸⁰ as discussed in Level III-J (Furniture).



2. Beds

a. **Non-Adjustable Platform Beds**⁴⁹³ – Beds without wire springs or storage drawers are preferred. These beds should be securely anchored in place to prevent patients from using them to barricade the door. If a portable lifting device will be used, beds are available with an opening underneath to accommodate the legs of the lift.⁴⁹⁴ Portable lifts can also be accommodated by placing an existing platform bed on a specially designed riser; this arrangement also reduces the amount of bending over staff need to do to work with the patient.^{494b}

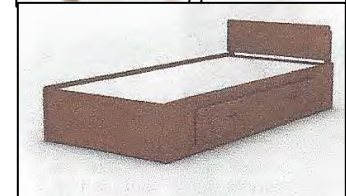

b. **Mattresses for Platform Beds**⁴⁹² – These should be specifically designed for use in behavioral health facilities and be resistant to abuse and contamination.



c. **Electric Hospital Beds** – If electrically operable beds are needed to reduce risk of staff injuries (especially for patients with co-existing medical issues), beds that are specifically suited for use on behavioral health units⁴⁹⁰ should be used rather than standard electrically adjustable hospital beds. These specialty beds will sense obstructions and reverse direction and have lockout features for the controls, reduced-length cords, and other tamper-resistant features. However, they do have significant ligature attachment point risks with the guard rails, headboard, footboard and allow access to many hazards beneath the bed.



If existing electrically operable beds must be used for financial reasons, use only beds that require a constant pressure on a switch located on the bed rail (not a remote-control device or paddle that can be placed on the

floor). Also, provide a key lockout switch on the beds (or a removable pigtail) so only staff can operate the beds. All electrical cords should be secured and shortened. Use of a keyed lockout switch is preferred.⁶¹¹ These beds also have significant ligature attachment risks as mentioned above.

As for other wheeled beds, the wheels of electric hospital-type beds should be removed or rendered inoperable.

3. **Wardrobe** – Wardrobe units should not have doors and should have fixed (non-adjustable) shelves.⁴⁹⁶ They should be securely anchored in place and have sloped tops. Wardrobes with clothes poles requiring hangers are discouraged because, although the bar can be made safe, the hangers present serious hazards. It should be noted that starting with the 2010 edition, the FGI *Guidelines* no longer calls for patient rooms to have accommodations for “hanging full-length clothing.” The average length of stay in many facilities is now in the 7-to-10-day range, and patients seldom come with clothing that needs to be hung up.



L. Miscellaneous

All requirements for lounges and activity rooms in Level III-L (Miscellaneous) apply to this level also.

1. **Nurse Call Switches** – Nurse call systems are generally not required for behavioral health units. If they are provided, pushbutton-type activation switches⁶⁵³ are preferred. If cords are provided, it is recommended they be no longer than 4” and as lightweight as possible. [In locations where patients may fall and need to reach the nurse call activation switch, a second switch should be installed within 12” of the floor, directly below the switch mounted at typical height.](#)
2. **Electrical Receptacles** – In new construction or major remodeling, provide a dedicated circuit for all electrical outlets in each patient room and bath. This will allow power to the outlets in a specific room to be turned off if necessary for a patient’s safety. Where this is not practical, the outlet may be temporarily covered.

It is strongly recommended that all electrical outlets in patient rooms and patient toilet rooms be a hospital-grade, tamper-resistant type. Use of GFCI receptacles⁶¹⁰ is also



preferred to reduce the risk of patients being able to harm themselves by tampering with the receptacles.

All electrical switch and outlet cover plates should be as discussed in Level III.

4. **Coat Hangers** – Use of hangers is not recommended.
5. **Cubicle Curtains and Tracks** – These are not recommended for use in behavioral health facilities because of the risk they present. If non-ambulatory patients with co-existing medical conditions are being treated on these units, it is recommended they be assigned to single-patient rooms.
5. **Telephone** – If desired, cordless phones may be provided to allow patients to check out a phone for private conversations when appropriate. Phones should not be left in patient rooms permanently because they can be used as weapons.
7. **Television Sets** – Typically, televisions should not be provided in patient rooms to encourage patients to use activity areas with other patients, which allows easier supervision. Some facilities that treat behavioral health patients with medical conditions that prevent them from being ambulatory provide televisions sets in tamper-resistant enclosures²⁹⁰ in patient rooms; these TVs have override controls for staff use.
8. **Medical Gas Outlets** – These are not normally required for behavioral health units. If there is medical necessity or the outlets are a preexisting condition in remodeling projects, they should be covered with lockable panels⁵⁹⁰ or panels attached with tamper-resistant screws. These should be removed only to address the medical needs of the current patient and replaced when that patient is discharged or moved. Special care must be taken in semi-private rooms to assure that access to the medical gases does not present a safety risk to the other patient. Some manufacturers offer lockable covers for outlets.
9. **Trashcans and Liners** – Trashcans and liner requirements listed for counseling and interview rooms in Level II also apply to this level. In choosing trashcans and liners, the potential for patient risk should always be assessed. Plastic liners should be prohibited because of the risk of suffocation. A substitute liner made of paper¹ may be used.

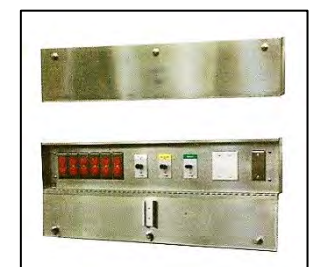

10. **Baseboards** – Use of thin, flexible rubber or vinyl baseboards that are applied only with adhesive and are intended to cover the joint between the wall and floor is strongly discouraged. These become prime targets for patient tampering and can be used to conceal contraband.

Finishing the wall surface to the floor, sealing the joint with pick-resistant sealant,²⁰ and painting a contrasting color stripe at the floor is preferred. There are several alternatives for locations where finishing the wall material to the floor is not practical:

- a. Seamless epoxy flooring²⁵⁰ that has an integral covered base is an exception to this as long as there is no metal edge strip on the top of the base.
- b. A pre-molded base²⁴⁰ that extends onto the floor plane, finishes flush with the top of the floor tile, and is heat-welded to the flooring may be acceptable in some locations. However, use of this product does not address the issue of hiding contraband unless the top edge is sealed with a pick-resistant sealant.²⁰
- c. A thick rubber base that resembles wood base profiles²⁴¹ is available and provides a more “residential” appearance. All joints to the wall and floor and all vertical joints should be sealed with a pick-resistant sealant.²⁰
- d. In some cases, a wood base with a minimum $\frac{3}{4}$ ” thickness that is adhered to the wall, secured with countersunk tamper-resistant fasteners, and sealed with pick-resistant sealant²⁰ has been used successfully. If desired, this can be given a semi-transparent stain finish to provide more of a residential look.

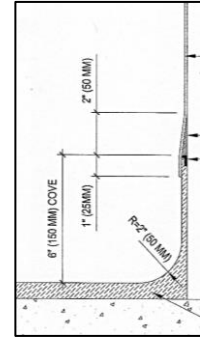
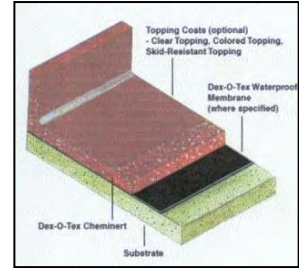

Level IV-b. Patient Toilet Rooms

A. **Floors** – Choose one of the following depending on the acuity of the patient population:

1. **Seamless Epoxy Flooring**²⁵⁰ – This flooring should have a slip-resistant finish and integral cove base and can be used in a shower. Do not use a metal or plastic strip at the top of the base as patients can remove it for use as a weapon.



2. **Ceramic and Porcelain Tile**. Larger tiles may be used (to reduce the number of joints) as long as the installation is maintained in good condition.

3. **One-Piece Floor Units** – These units⁵⁶⁴ provide a monolithic floor (European-style) for the entire patient toilet room that drains the shower to a central location. If used in conjunction with location of the shower enclosure and shower head, this unit can eliminate the need for shower curtains.

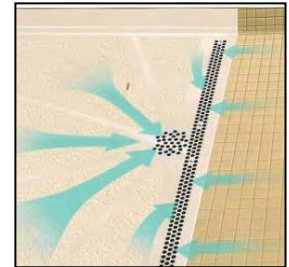

4. **Solid-Surface Material Floors** – These are available with a trench drain⁵⁶⁴ across the entire front opening of the stall, which not only helps keep water from getting into the room, but also makes the drain more difficult for patients to intentionally clog. Fiberglass shower stalls and floors are generally not durable enough.

5. **Ligature-Resistant Floor Drains** – Are available for both standard round drains^{565a,b} and trench drains.^{565c} Trench drains may require regular cleaning to avoid unwanted odors.

6. **Pre-Built Bathrooms**⁵⁶⁸ – These contain all finishes, fixtures, and accessories and can reduce construction time because they are shipped to the site ready to be connected to the utilities.



B. **Walls** - Use one of the following depending on the acuity of the patient population and the project budget:

1. Synthetic wall protection panels³³¹ (without trim pieces) or solid-surface sheet material
2. Ceramic or porcelain tile in large pieces
3. Gypsum board that is impact-resistant and has mold- and moisture-resistant facing²³⁰ with epoxy paint; solid-surface sheets in showers

- C. **Ceiling** – Gypsum board with mold- and moisture-resistant facing²³⁰ with epoxy paint is recommended.
- D. **Glass** – Mirrors, same as for patient rooms in Level Iva.
- E. **Door** – The first question to address for patient toilet room doors is whether the facility ever has the need/desire to lock patients out of their bathrooms.

1. If there is a need to lock patients out of the bathroom:

- a. A full-size, tight fitting, out-swinging door mounted on a single-acting continuous hinge with hospital tip and over-door alarm¹⁵⁰ will need to be installed. Also, a classroom function deadbolt¹⁴³ (with a ligature-resistant turn piece that will retract the bolt but not extend it), two flush pulls¹²¹ mounted back to back (larger pulls^{121d} available for ADA accessible rooms), and a roller,¹⁴⁶ ball¹⁴⁵ or magnetic¹⁴⁸ latch should be installed.
- b. A full-size, tight fitting, double-acting door mounted on double acting continuous hinge^{113c} with a hinge restrictor cap, rubber fin with a ligature resistant cap,^{40e} ligature-resistant dead bolt that extends into the head of the frame, over the door alarm and two flush pulls is another option.
- c. A sliding door¹⁵⁵ that is ligature resistant can eliminate issues with swinging door conflicts or floor space issues as long as there is wall surface for it to slide over in the open position. Ligature resistant pulls and locking hardware are available for this configuration.

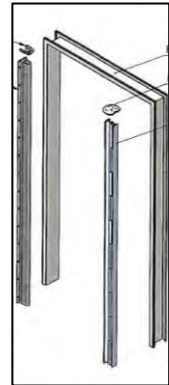

2. If it is not necessary to lock patients out of their bathrooms, one of the following options may be provided:

- a. b. **Soft Suicide Prevention Door (SSPDoor)^{40b}** – This door eliminates many of the hanging hazards associated with a typical door. It is attached with magnets and may be easily removed by staff for use as a shield against an attacking patient. A photograph can be printed on its faces. This door cannot be locked or latched in any manner. (Use of this product eliminates the need for the items listed under “Hardware” below.)
- c. **Sentinel Event Reduction Door⁴⁰** – One of these doors without a movable top panel is another option. Privacy for



two patient rooms can be improved slightly by installing the door a little higher than normal.

- d. **No Door** - Some facilities with single-patient rooms are electing to remove doors entirely from patient toilet rooms. The practicality of this depends on the sight line into the toilet room from the corridor door.

F. **Hardware** - See Section II-E.

G. **Light Fixtures** – Same as patient rooms in Level IVa except that fixtures shall be water-resistant with a sealed polycarbonate lens. No glass components should be used in any fixture.

H. **Fire Sprinklers, Institutional Type** – Same as for corridors in Level II

I. **HVAC Grilles and Equipment** – Fully recessed, vandal-resistant grilles with S-shaped air passageways⁶⁰⁰

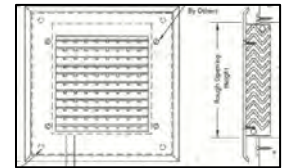

J. **Miscellaneous**

1. **Medicine Cabinets** – These should not be provided because of the difficulty in observing potentially dangerous items that may be placed in them.

2. **Robe Hooks** – Evaluate the risk of using these hooks. If they are required, they should be the collapsible type.³⁵⁰



3. **Towel Bars** – Use collapsible hooks³⁵⁰ instead of towel bars for towels.

4. **Grab Bars** – Because some patients may be on medications that interfere with their equilibrium, grab bars for toilets and showers are recommended for all patient-accessible toilets. A self-draining bar³³² may be installed on a slight slope. These provide a high degree of safety and are also easy to clean and sanitize. If the wall surface behind the bar is not smooth and flat, provide pick-resistant sealant to the joint between the bar and the wall.



5. **Vertical Grab Bars** – In locations where vertical grab bars are required or desired, typical ligature-resistant bars mounted vertically can usually be grasped only from one side. A ligature-resistant grab bar specifically designed to be mounted vertically³³⁷ can be grasped from either side.

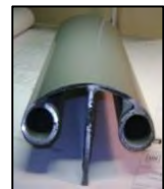

Cross-section

6. **Shower Curtains and Curtain Tracks** – No shower curtains or their tracks of any type (including those designated as “breakaway” and represented by their manufacturers as “safe for psychiatric hospitals”) are recommended for use in any patient-accessible areas, especially patient showers. In new construction, showers could be designed to contain the spray within the compartment without the use of a curtain. In existing facilities, the use of a Soft Suicide Prevention Shower Door^{40b} or Sentinel event reduction door⁴⁰ mounted with a minimal gap between the bottom of the door and the floor may be used for 36-inch or narrower openings. A Sentinel Event Reduction Shower Door⁴¹ with a seal on the bottom may also be provided.

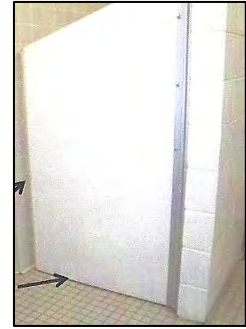

7. **Nurse Call Switches** – Where nurse call switches are required or provided, they should be a ligature-resistant, push-button type.⁶⁵³ If pull cords are provided, they should be no longer than 4” and as lightweight as possible. In locations where patients may fall and need to reach the nurse call activation switch, a second switch should be installed within 12” of the floor, directly below the switch mounted at typical height.

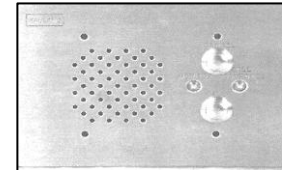

8. **Lavatories** – Typical commercial solid-surface countertops with integral sinks offer a much less institutional appearance. They also provide a place for patients to set their toothbrushes, etc. Specialty vanity top-type lavatories⁵⁴² provide many of the same benefits.



9. **Wall-Hung Solid-Surface Lavatories** – Corner lavatories⁵⁴⁰ make ligature attachment difficult and some come with the ADA required 18” space from the wall to the centerline of the drain and matching pipe enclosure.



If a wall-hung fixture is used that does not fit into a corner,³⁴¹ the optional filler panel is recommended to fill the space between the side of the fixture and an adjacent wall when there is one near the fixture. Stainless steel or high-impact polymer pipe covers designed for the lavatories that fit beneath the unit should also be provided.



10. **Lavatory and Sink Faucets and Valves** – Faucets and valves can provide attachment points for ligatures. A lavatory valve unit is now available that uses a shower valve fitted with a ligature-resistant handle⁵⁷⁴ to allow patients to control the temperature (thermostatically limited to prevent scalding) and duration of the water flow. This valve can be used to replace the motion sensor activation of some



faucets. Faucets are available in a variety of materials and configurations that range from push-button to motion sensor-activated.⁵⁷⁰



11. **Lavatory Waste and Supply Piping** – All piping of this type must be enclosed so it is not accessible to patients.⁴¹⁰

Extreme care should be taken to trim the enclosing material so it fits tightly to the underside of the lavatory fixture to prevent the patient from using this space to hide contraband.



12. **Soap Dishes** These should not have handles and should be recessed. Soap dishes that can be installed from the front^{390a} should be ordered unless there is access to the chase behind the wall for installation



13. **Soap Dispensers** – Many facilities now use liquid or foam soap in patient areas, but the commonly used hard-plastic soap dispensers are problematic in that they are fairly easy to pull off the wall and break into sharp shards that can be used as weapons. At least one manufacturer now offers steel covers for their standard dispensers. Another solution is a dispenser made of solid-surface material³⁹¹ commonly used for countertops that is relatively tamper-resistant. Some commercially available stainless steel dispensers are reasonably ligature-resistant.

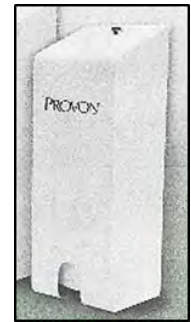

14. **Toilets** – Toilets used by behavioral health patients should be a floor-mounted, back outlet, back water supply type rather than a wall-mounted fixture, which can be broken off its hangers. Currently, the only china fixtures in this configuration are ADA handicapped-accessible fixtures.⁵³¹ Where wall-hung toilets or floor mounted fixtures that do not fit tightly to the wall exist and replacing them is not practical, some facilities have had stainless steel or solid surface filler panels custom fabricated to fill the voids.



Movable seats provide attachment points for ligatures, so their use should be considered carefully by each hospital. The solution is to use a fixture with an integral seat as suggested above. Some facilities feel this is too prison-like and choose to accept the risk of the movable seat.



China fixtures themselves (both floor- and wall-mounted) can be broken into large, sharp shards. Toilet fixtures made of solid-surface material⁵³³ and stainless steel⁵³⁴ are available and are much more resistant to breakage. The stainless steel fixtures can be powder-coated for a less “institutional” appearance.

Toilet fixtures that will support loads in excess of 2,500 pounds are available if needed for patients of size.⁵³⁶

16. **Toilet Waste Line Clog Removal Assistant** – Patients in behavioral health facilities have been known to attempt to clog toilets with various materials. A product is now available to help simplify removal of material clogging waste lines.⁵³⁷ This is installed in the waste line immediately adjacent to the fixture and is intended to catch the material at that location, where it can be removed more easily by maintenance staff.

17. **Flush Valves** – Toilet flush valves that are recessed in the wall⁵⁸⁰ and activated by a push button⁵⁸¹ are preferred. Where this is not practical, the flush valve and all related pipes should be enclosed with a stainless steel⁵⁸⁵ or plastic^{585b} cover with a sloped top that incorporates a push-button activator for the valve.

18. **Toilet Paper Holders**

- a. Toilet paper holders⁴⁰⁰ that do not require a bar or tube to hold the paper allow for standard use of the roll of toilet paper without requiring everyone using the roll to handle it. [They are available in recessed and surface mounted styles and some have no moving parts.](#)
- b. Other toilet paper holders use a bar(s) that pivots down^{400f,g} when vertical pressure is imposed.

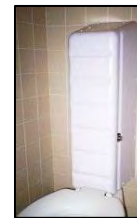

19. Shower Control Valves

Note: Provide **thermostatically limited hot water** to prevent accidental or intentional scalding in all patient-accessible toilet rooms.

- a. Single-knob mixing valves that provide minimal opportunity for tying anything around them are preferred.⁵⁵² These give patients control of the water temperature and duration of flow. Some of these are claimed to be ADA-compliant by their manufacturers.
- b. If it is only necessary to replace the valve handles and the valve itself is working properly, use of a replacement valve handle^{552c} that can be adapted to a variety of valves might be considered. *Note:* This may void any remaining warranty on the existing valve.
- c. A “no-touch” valve^{552e} that appears to be clearly ADA compliant is available. It utilizes infrared controls to give patients control of a range of water temperatures and the duration of flow.
- d. One-piece shower assemblies that contain a shower head, push-button valves, and a recessed soap dish⁵⁶⁰ work well for remodeling projects because they reduce the amount of repair needed for wall finishes. These are also available with a second head^{563c} located 48” above the floor and a diverter valve if needed for ADA purposes.



20. **Shower Heads** – These should be a ligature-resistant institutional type.⁵⁵⁰ Handicapped-accessible showers are required to have either a handheld shower head or a second, lower head 48” above the floor. The handheld shower head should be on a ligature-resistant, quick-disconnect fitting⁵⁶³ that allows removal of the head and attached hose when not in use. If a hook is provided to hold the handheld showerhead, it should be mounted on the part of the fitting that is removed when the hose is removed. [A ligature resistant shower head with integral quick-disconnect fitting and internal diverter valve⁵⁵¹ is available which reduces the clutter of individual items.](#) Another option

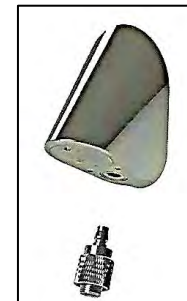
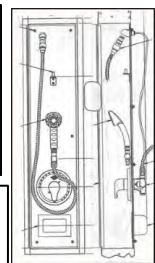

is to provide a lockable cabinet to house the handheld head and valve.⁵⁶²

21. **Shower Drains** – That offer less opportunity for ligature attachment or patients abrading their skin⁵⁶⁵ are preferred over more traditional drain grates.

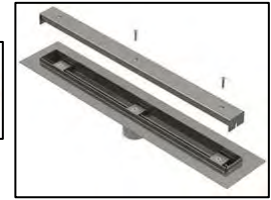

22. **Diverter Valve** – If a diverter valve is needed to change the water flow from the standard shower head to the ADA-required head,⁵⁵⁵ a ligature-resistant diverter valve may be provided.



23. **Folding Shower Seats** – Shower seats that fold away typically have many tubes and brackets that are hazardous. If a folding shower seat is necessary, one without the tubes and brackets³⁸⁰ is suggested.



23. **Shelves** – Shelves to hold miscellaneous items are often requested in shower stalls and near wall-hung lavatories. A stainless steel suicide-resistant shelf that is either surface-mounted³⁷¹ or recessed into the wall,³⁷⁰ may be considered for these applications. Front mounted recessed units are preferred unless access to the chase is provided.



24. **Paper Towel Dispensers** – Paper towel dispensers are a concern in patient-accessible toilets because they typically are constructed of light-weight materials that can either be broken or bent to form sharp objects that may be used as weapons. Alternatives are as follows:



- Place a small stack of paper towels on a surface-mounted or recessed shelf.
- Provide a heavy-gauge, vandal-resistant dispenser.^{340b}
- Install a heavy-duty secure cover^{340a} over a standard-weight paper towel dispenser.



25. **Electrical Receptacles** – Providing ground-fault circuit interrupter (GFCI)-type electrical circuit breakers for all receptacles near sources of water (e.g., lavatories, toilets, and showers) and in all patient-accessible areas is required by the FGI *Guidelines*.

Level V-a. Admissions

If possible, the admissions function should not take place on an inpatient unit. At admission, unit staff members know very little about a new patient and his or her trigger points. A separate location for admission avoids disrupting either the unit or the new patient due to the agitation of either.

This room should be pleasant and welcoming and should be minimally furnished (with a few loose pieces of furniture).

The room should be large enough to allow for several staff to physically manage the patient if necessary. If possible, the admitting staff member should not be in the room alone with a patient. After the admitting process is complete, the patient can be escorted to the unit. These precautions are particularly important for emergency admissions, which frequently occur at night and on weekends.

A. **Floors** – Same as activity rooms and lounges in Level III

B. **Walls** – Same as patient rooms in Level IV

C. **Ceiling** – Same as patient rooms in Level IV

D. **Glass**

1. Same as in Level IV
2. Provide a small (12"x12" or 4"x24") view window in the door that can be controlled by staff²²⁰ to restrict views into or out of this room.

E. **Hardware** – Same as in Level IV

F. **Light fixtures** – Same as in Level IV

G. **Fire Sprinklers, Institutional Type** – Same as in Level IV

H. **HVAC Grilles** – Fully recessed, vandal-resistant grilles with S-shaped air passageways⁶⁰⁰ Same as in Level IV

I. **Window Covering Hardware** – Same as in Level IV

J. **Miscellaneous**

1. All miscellaneous requirements listed for corridors in Level II also apply to this level.
2. An emergency call button⁶⁵⁴ for use by staff should be provided so staff may summon additional staff members if

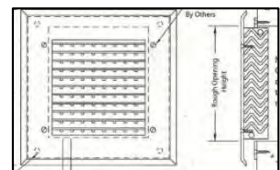
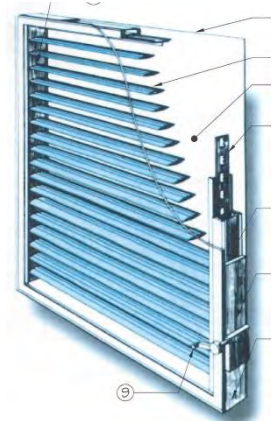

necessary unless personal duress alarm devices⁶⁵⁰ are provided to staff that include notification of their current location.

3. Baseboards same as patient rooms in Level IV

K. Furniture

1. This room should have a built-in desk or table that is firmly attached to the floor or walls and contains a lockable file drawer for forms and a lockable box drawer for pens, pencils, staplers, etc. All loose items should be kept in drawers and out of sight. The furniture arrangement should locate the patient chair so the patient, when seated, will not be between the staff member and the door to the room.
2. The computer, printer, and telephone should be located so the patient cannot easily reach them. The use of tablet computers and cordless phones in these rooms is preferable.
3. Seating should be fixed in place or heavyweight as discussed in Level II-M (Furniture).

Level V-b. Seclusion Rooms

Seclusion rooms are required by the FGI *Guidelines* to be no less than 7 feet wide and no greater than 11 feet long to avoid providing enough space for a patient to get a running start at the opposite wall. They should be designed to minimize blind spots where patients cannot be observed by staff without entering the room. A minimum ceiling height of 9 feet is preferred. The distance of the seclusion room from the nurse station needs to be considered. The goal is to avoid excessive distance so staff can be readily available as needed. The seclusion room door should open directly into an anteroom to separate these activities from other patients and give the patient access to a toilet without entering the corridor.



A. **Floor** – Continuous sheet vinyl with foam backing and heat-welded seams²⁷² or padded flooring to match wall padding, if used

B. **Walls** – Impact-resistant gypsum board²³⁰ over 3/4” plywood on 20-gauge metal studs at 16” on center with high performance finish.²⁸⁰ If wall padding is desired, use of systems with Kevlar-facing or heavy vinyl facing with a 1 1/2” thick foam backing²⁷⁰ may be considered.

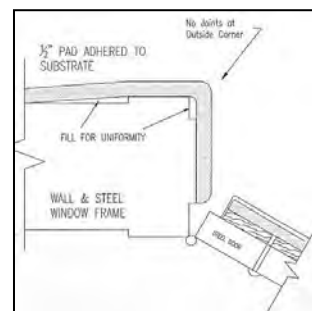



One facility has encountered issues with authorities having jurisdiction when using plywood for this purpose and has substituted 25-gauge sheet metal, which stiffens the wall, is easily cut and does not require wider door frames.

C. **Ceiling** – Impact-resistant and/or abrasion-resistant gypsum board^{230, 231} painted at 9'-0" minimum height.

D. **Glass** – All glazing exposed to patients should be the same as in Level II-D.

E. **Hardware**

1. **Doors** – Heavy-duty, commercial-grade steel doors with a minimum clear width of 3'-8" that are hinged to open out of the room with a polycarbonate²⁰¹ view window not to exceed 100 square inches should be used. The window should be installed at a height that allows shorter staff members to see into the room.

2. **Door Hardware** – Exposed door hardware is typically not provided inside these rooms.

The seclusion room door should have three-point latching, which may be individual bolts¹⁶² or one piece of hardware with a single lever to operate all three bolts.¹⁶⁰ Consideration should be given to whether the behavioral health organization wants to have hardware that latches immediately when the door is closed or hardware that requires manual motion to latch the door. A self-latching door may increase the risk of staff becoming locked in the room with a patient, and a keyed cylinder (or concealed card reader) may need to be accessible from inside the room.

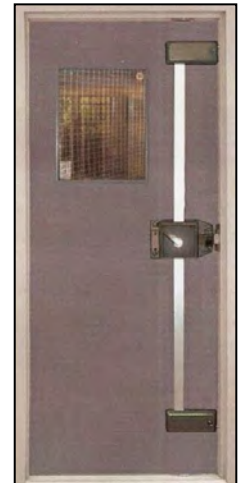
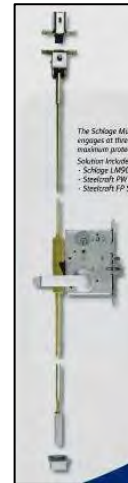

F. **Light Fixtures** – Fully recessed, moisture-resistant, vandal-resistant light fixtures⁶²⁰ installed in the ceiling are recommended.

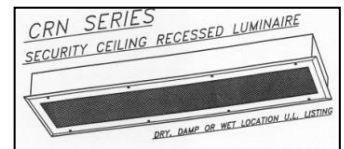

G. **Fire Sprinklers, Institutional Type** – Same as for Level IV



H. **HVAC grilles**

1. Fully recessed, vandal-resistant grilles with S-shaped air passageways⁶⁰⁰

2. **Thermostats** – These should be a digital type with control mounted on the wall in the anteroom and sensor in the return air duct serving the room.

I. **Window Covering** – No window covering material or hardware should be accessible to the patient. All window coverings should be behind safety glazing as described in Level II-D. Mini-blinds, roller shades, or other types of window covering may be used behind the safety glazing as long as only staff can operate them and no ligature attachment points are provided by the system. If electrically operated devices are chosen, controls should be located in the anteroom.

J. Miscellaneous

1. No electrical outlets, switches, thermostats, blank cover plates, or similar devices are permitted inside seclusion rooms.
2. **Toilets** – Same as those in Level IV-B. Powder-coated stainless steel fixtures are preferred by some facilities.
3. No baseboards should be used in these rooms.
4. **Observation Mirror** – Install a convex mirror⁴²⁰ like that required for glass in corridors in Level II-L-8 (Observation Mirrors). Locate the mirror in the upper corner of the room opposite the seclusion room door. Make sure the mirror can be seen when viewing it from the window in the door. This mirror will give staff a full view of the room prior to opening the door. Care shall be taken to assure the attachment is secure so the patient cannot remove it and have a weapon.



K. **Furniture** – A seclusion room should have only a behavioral health care mattress⁴⁹² on the floor or a special seclusion room bed.^{493a, 498} These beds are available with loops to which mechanical restraints may be attached, if needed. **Care should be taken if the restraint attachment loops are provided in rooms where patients will not be in restraints because they become ligature attachment points.**



SUMMARY

Thoughtful consideration of these design elements and materials by design team members and hospital staff can result in a very aesthetically pleasing environment that will enhance the treatment process and help maximize safety for patients, staff, and visitors. It is strongly recommended that wall-hung lavatories, 2'x4' fluorescent light fixtures, paddle-handle door hardware, and many other items typically found in general hospitals **NOT** be used in behavioral health facilities. The reasons these are used in general hospitals typically do not exist in behavioral health care units. Their elimination will significantly reduce the institutional character of behavioral health facilities without decreasing patient or staff safety. As stated in the introduction, this document is intended to represent leading current practices and does not establish minimum standards for behavioral health facilities and no product is without risk.

APPENDIX INDEX

Trash Receptacle Liners - 55	12 35 70 – Healthcare Case Work - 95
07 00 00 – Thermal & Moisture Protection - 55	12 44 16 – Shower Doors - 98
07 92 00 - Joint Sealants	12 46 23 – Decorative Crafts - 99
08 00 00 - Openings - 57	12 52 70 - Healthcare Seating - 100
08 10 00- Doors & Frames - 57	12 56 70 - Healthcare Furniture - 104
08 34 00 – Special Function Doors - 57	12 93 43 - Site Furnishings, Seating & Tables - 110
08 31 13 - Access Doors & Frames - 59	21 00 00 - Fire Suppression - 111
08 51 13 – Aluminum Windows - 60	21 13 13 - Fire Suppression Sprinkler Systems -111
08 56 56 - Security Window Screens - 62	22 43 00 - Healthcare Plumbing Fixtures - 111
08 71 00 - Door Hardware - 62	22 43 13 - Healthcare Water Closets - 111
08 87 53 - Security Films - 74	22 43 16 - Healthcare Sinks - 113
08 88 53 - Security Glazing - 75	22 43 19 - Healthcare Bathtubs & Showers - 114
09 00 00 – Finishes - 77	22 43 23 - Healthcare Shower Recept. & Basins - 119
09 21 16 - Gypsum Board - 77	22 43 39 - Healthcare Faucets - 121
09 50 00 – Ceilings - 79	22 43 43 - Healthcare Plbg. Fixt. Flushometers - 122
09 65 13 - Resilient Base - 79	22 47 00 – Water Station Water Coolers - 124
09 65 16 - Resilient Flooring - 80	22 60 00 – Gas & Vacuum Systems - 125
09 67 00 - Fluid-Applied Flooring - 81	23 00 00 - Heating, Ventilating & Air Cond. - 126
09 68 16 - Sheet Carpeting - 81	23 37 13 - Diffusers, Registers & Grilles – 126
09 77 00 - Special Wall Surfacing - 81	26 00 00 - Electrical - 128
09 96 13 – Abrasion Resistant Coatings - 82	26 27 26 – Electrical Devices - 128
10 00 00 – Specialties - 82	26 51 00 – Interior Lighting - 129
10 12 00 – Display Cases - 82	26 53 00 – Exit Signs - 133
10 14 00 – Signage - 83	26 55 53 – Security Lighting - 134
10 26 16.16 – Protective Corridor Handrails - 84	27 00 00 – Communications - 134
10 26 23 – Protective Wall Covering - 84	27 32 13 - Telephone Sets - 134
10 28 13 - Security Toilet Accessories - 85	27 52 23 – Nurse Call/Code Blue Systems - 135
10 86 00 – Security Mirrors & Domes - 93	28 00 00 – Electronic Safety and Security - 136
12 00 00 – Furnishings - 93	28 40 00 – Electronic Monitoring and Control - 136
12 21 13 – Horizontal Louver Blinds - 93	32 00 00 – Exterior Improvements - 136
12 21 33 – Roll-Down Blinds - 95	32 31 13 - Security Fencing - 136

PLEASE NOTE:

Product information included in this document is intended for illustration of one or more specific items that are deemed appropriate for use in this type of facility. Comparable products by other manufacturers that meet the same design criteria may be substituted after careful comparison. No products are completely without risk. [All product selections should be made in compliance with the findings of the comprehensive safety risk assessment for each location.](#)

1a. Trash receptacle liner – paper

Sani-Liner®

Wisconsin Converting
 1689 Morrow Street
 Green Bay, WI 54302
 920-593-8297

www.wisconsinconverting.com



1c. Trash receptacle liner – paper

Psych-Select-Bag™

Dano Group
 150 Harvard Avenue
 Stamford, CT 06902
 800-348-3266

www.danoinc.com



07 00 00 – THERMAL AND MOISTURE PROTECTION

07 92 00 - JOINT SEALANTS

10a. Sound and smoke/fire seals – breakaway

Cush 'N' Seal with breakaway anti-ligature option

Door and Hardware Systems, Inc.
 17 Silver Street
 Rochester, NY 14611
 585-235-8543

www.dhsi-seal.com/

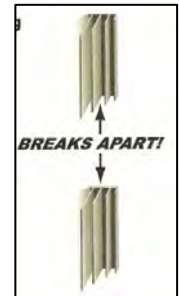

10b. Sound and smoke/fire seals – breakaway

Ligature-resistant Zag option

Zero International – Allegion
 2720 Tobey Dr.
 Indianapolis, IN 46219
 877-671-7011

www.zerointernational.com

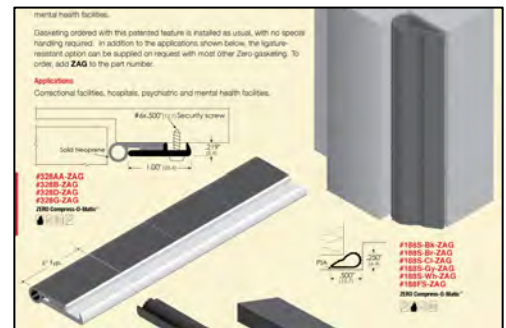

PLEASE NOTE:

Product information included in this document is intended for illustration of one or more specific items that are deemed appropriate for use in this type of facility. Comparable products by other manufacturers that meet the same design criteria may be substituted after careful comparison. No products are completely without risk. All product selections should be made in compliance with the findings of the comprehensive safety risk assessment for each location.

10c. Sound and smoke/fire seals – breakaway

Adhesive gaskets - perforated

Pemko Manufacturing Company
5535 Distribution Drive
Memphis, TN 38141
800-824-3018
www.pemko.com

20a. Pick-resistant caulk

Dynaflex™ SC

Pecora Corporation
165 Wambold Road
Harleysville, PA 19438
800-523-6688
www.pecora.com

20b. Pick-resistant caulk

SB-190 Everseal

Surebond
3925 Stern Avenue
St. Charles, IL 60174
877-843-1818
www.surebond.com



20c. Pick-resistant caulk

Mastereal® CR 190

BASF Construction Chemicals
889 Valley Park Drive
Shakopee, MN 55379
800-243-6739
www.master-builders-solutions.basf.us

PLEASE NOTE:

Product information included in this document is intended for illustration of one or more specific items that are deemed appropriate for use in this type of facility. Comparable products by other manufacturers that meet the same design criteria may be substituted after careful comparison. No products are completely without risk. [All product selections should be made in compliance with the findings of the comprehensive safety risk assessment for each location.](#)

08 00 00 - OPENINGS

08 10 00- DOORS AND FRAMES

25a. Synthetic faced door

C/S Acrovyn® Doors

Construction Specialties
3 Werner Way
Lebanon, NJ 08833
800-972-7214
www.c-sgroup.com



25b. Synthetic-faced door

Thermal-Fused Doors

ASSA ABLOY Door Group
c/o Maiman
3839 East Mustard Way
Springfield, MO 65803
417-616-8234
www.assaabloywooddoors.com



08 34 00 – SPECIAL FUNCTION DOORS

40a. Patient toilet door

Sentinel Event Reduction Door

Norva Plastics, Inc.
3911 Killam Ave.
Norfolk, VA 23508
800-826-0758
www.norvaplastics.com



40b. Patient toilet door

Soft Suicide Prevention Door

Kennon Products, Inc.
2071 North Main Street
Sheridan, WY 82801
307-674-6498
www.suicideproofing.com



PLEASE NOTE:

Product information included in this document is intended for illustration of one or more specific items that are deemed appropriate for use in this type of facility. Comparable products by other manufacturers that meet the same design criteria may be substituted after careful comparison. No products are completely without risk. [All product selections should be made in compliance with the findings of the comprehensive safety risk assessment for each location.](#)

40e. Patient toilet door

Swing Hinge & Rubber Hinge w/ top Plates

Kingsway Group USA

2807 Samoset Road

Royal Oak, MI 48073

800-783-7980

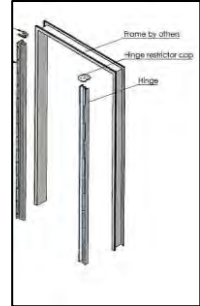
www.kingswaygroupusa.com

41a. Patient shower door

Suicide-Resistant Shower Door

Norva Plastics, Inc.

3911 Killam Ave.

Norfolk, VA 23508

800-826-0758

www.norvaplastics.com

44b. Wicket doors

C/S Acrovyn® Barrier-Resistant Doors

Construction Specialties

3 Werner Way

Lebanon, NJ 08833

800-972-7214

www.c-sgroup.com

44c. Wicket doors

Behavioral Health Series Patient Room Access Door

ASSA ABLOY Door Security Solutions

110 Sargent Drive

New Haven, CT 06511

800-377-3948

www.assaabloydss.com

44d. Wicket doors

Wicket Door (Wood Doors)

Marshfield Door Systems

1401 East Fourth Street

Marshfield, WI 54449

800-869-3667

www.marshfielddoors.com**PLEASE NOTE:**

Product information included in this document is intended for illustration of one or more specific items that are deemed appropriate for use in this type of facility. Comparable products by other manufacturers that meet the same design criteria may be substituted after careful comparison. No products are completely without risk. All product selections should be made in compliance with the findings of the comprehensive safety risk assessment for each location.

44e. Wicket doors

GCD-EC Flush Wicket Door with structural composite lumber core

Graham Wood Door
 525 9th St. SE
 Mason City, Iowa 50401
 641-423-2444
www.grahamdoors.com

47a. Security sidelight

Security Sidelite Unit

Curries Company
 1502 12th St. NW
 Mason City, IA 50401
 641-423-1334
www.curries.com



47b. Security sidelight

Security SideLite Unit

Ceco Door
 9159 Telecom Drive
 Milan, TN 38358
www.cecodoor.com

**08 31 13 - ACCESS DOORS AND FRAMES**

50. Access panel – lockable

SP Steel Security Panel with mortise deadbolt prep

J. L. Industries, Inc.
 4450 West 78th Street Circle
 Bloomington, MN 55435
 800-554-6077
www.jlindustries.com

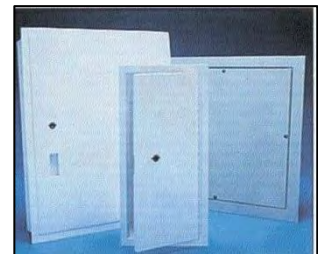
**PLEASE NOTE:**

Product information included in this document is intended for illustration of one or more specific items that are deemed appropriate for use in this type of facility. Comparable products by other manufacturers that meet the same design criteria may be substituted after careful comparison. No products are completely without risk. All product selections should be made in compliance with the findings of the comprehensive safety risk assessment for each location.

08 51 13 – ALUMINUM WINDOWS

60a. Aluminum window with integral blind

2450 Series Storefront with hinged sash and integral blind

Manko Window Systems, Inc.
800 Hayes Drive
Manhattan, KS 66502
800-642-1488
www.mankowindows.com

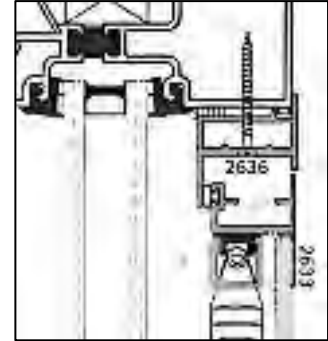

60b. Aluminum window with integral blind

2187-DT Psychiatric Windows with integral blind

Wausau Window and Wall Systems
7800 International Drive
Wausau, WI 54401
877-678-2983
www.wausauwindow.com

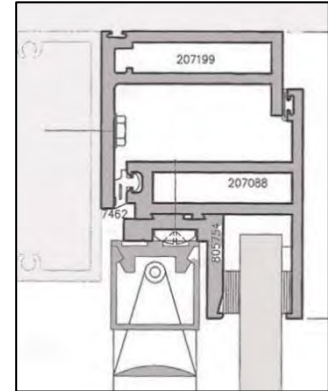

60c. Aluminum window with integral blind - removable

SS-5100 Medium-Security Mental Health Security Window

Sherwood Windows Group
37 Iron Street
Toronto, Ontario M9W 5E3
Canada
800-770-5256
www.sherwoodwindows.com

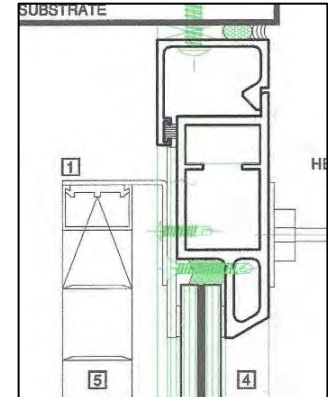

PLEASE NOTE:

Product information included in this document is intended for illustration of one or more specific items that are deemed appropriate for use in this type of facility. Comparable products by other manufacturers that meet the same design criteria may be substituted after careful comparison. No products are completely without risk. All product selections should be made in compliance with the findings of the comprehensive safety risk assessment for each location.

61a. Exterior windows - ventilation

Safevent Windows

Britplas
Unit 18 Kingsland Grange
Woolston, Warrington WA1 4RW
England
+44-1925-824317
www.britplas.com



61b. Exterior windows - ventilation

SW-6300 Operable Security Window

Sherwood Windows Group
37 Iron Street
Toronto, Ontario M9W 5E3
Canada
800-770-5256
www.sherwoodwindows.com



61c. Exterior windows - ventilation

512 Ventrow Ventilator

Kawneer North America
Technology Park / Atlanta
555 Guthridge Court
Norcross, GA 30092
770-449-5555
www.kawneer.com

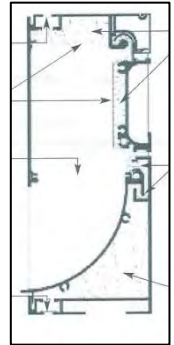
**PLEASE NOTE:**

Product information included in this document is intended for illustration of one or more specific items that are deemed appropriate for use in this type of facility. Comparable products by other manufacturers that meet the same design criteria may be substituted after careful comparison. No products are completely without risk. All product selections should be made in compliance with the findings of the comprehensive safety risk assessment for each location.

08 56 56 - SECURITY WINDOW SCREENS

80. Security screens

Security Screens

Kane Innovations
 2250 Powell Avenue
 Erie, PA 16506
 800-773-2439
www.kanescreens.com

08 71 00 - DOOR HARDWARE

100a. Door closer

2010 Series Concealed closer

LCN
 121 West Railroad Avenue
 P.O. Box 100
 Princeton, IL 61356-0100
 877-671-7011
<http://us.allegion.com/brands/lcn/Pages/default.aspx>



100b. Door closer

4510T SMOOTHIE® Series high-security track closer

LCN
 121 West Railroad Avenue
 P.O. Box 100
 Princeton, IL 61356-0100
 877-671-7011
<http://us.allegion.com/brands/lcn/Pages/default.aspx>

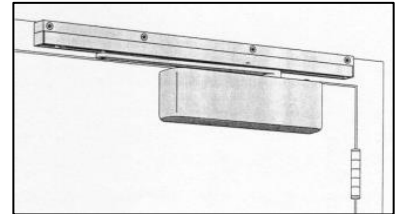

101. Electrically controlled door closer

Fire/Life Safety Series HSA Sentronic Electrically Controlled Closer/Holder

LCN
 121 West Railroad Avenue
 P.O. Box 100
 Princeton, IL. 61356-0100
 815-875-3111
<http://us.allegion.com/brands/lcn/Pages/default.aspx>

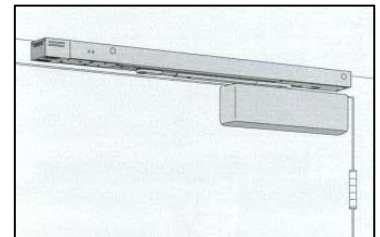
**PLEASE NOTE:**

Product information included in this document is intended for illustration of one or more specific items that are deemed appropriate for use in this type of facility. Comparable products by other manufacturers that meet the same design criteria may be substituted after careful comparison. No products are completely without risk. All product selections should be made in compliance with the findings of the comprehensive safety risk assessment for each location.

109. Electric-release concealed deadbolts

ELECTRA™ concealed vertical rod latching lever locksets

Securitech Group, Inc.
 54-60 46th Street
 Maspeth, NY 11378
 800-622-5625
www.securitech.com

110. Electromagnetic lock

Electromagnetic Locks

DynaLock Corporation
 705 Emmett Street
 Bristol, CT 06010
 877-396-2562
www.dynalock.com



111a. Continuous hinges – gear type with hospital tip

780-Series Roton Hinges

Hager Companies
 139 Victor Street
 St. Louis, MO 63104
 800-325-9995
www.hagerco.com/Product-Listing.aspx?CatID=152&SubCatID=189



111b. Continuous hinges – gear type with hospital tip

112HD Concealed Continuous Hinge

Ives
 2720 Tobey Dr.
 Indianapolis, IN 46219
 877-671-7011
<http://us.allegion.com>

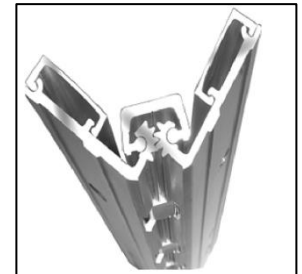
***PLEASE NOTE:***

Product information included in this document is intended for illustration of one or more specific items that are deemed appropriate for use in this type of facility. Comparable products by other manufacturers that meet the same design criteria may be substituted after careful comparison. No products are completely without risk. [All product selections should be made in compliance with the findings of the comprehensive safety risk assessment for each location.](#)

- 111c. Continuous hinges – gear type with hospital tip
825-S22 SR™ SR824-S22 SafeSupport Continuous Gear Hinge
 Weizel Security
 800-308-3627
www.secur_inghospitals.com

- 111d. Continuous hinges – gear type with hospital tip
Continuous Gear Hinge with hospital tip, mortise mount – DH430
 Behavioral Safety Products
 29A N. Main St., Suite 3
 Watkinsville, GA 30677
 706-705-1500
www.besafepro.com

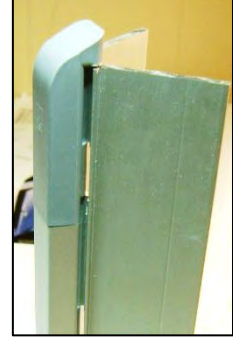

- 111e. Continuous hinges – gear type with hospital tip
KG200 Continuous Geared Hinge
 Kingsway Group USA
 2807 Samoset Road, Suite 200
 Royal Oak, MI 48073
 800-783-7980
www.kingswaygroupusa.com



- 111f. Continuous Hinges – gear type with hospital tip
SL11 Conceald single acting continuous geared hinge
 Select Products Limited
 9770 Shaver Road
 Portage MI 49024
 800-423-1174
www.selecthinges.com



PLEASE NOTE:

Product information included in this document is intended for illustration of one or more specific items that are deemed appropriate for use in this type of facility. Comparable products by other manufacturers that meet the same design criteria may be substituted after careful comparison. No products are completely without risk. All product selections should be made in compliance with the findings of the comprehensive safety risk assessment for each location.

113a. Double-acting continuous hinge

Double Swing Hinge –DSH1000 Barrel Type

Markar
 P. O. Box 18966
 Memphis, TN 38181

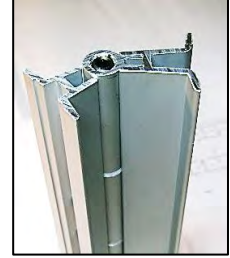

<https://www.assaabloydooraccessories.us/en/local/assaabloydooraccessories/products/hinges/continuous-pin-barrel-hinges/behavioral-health-hinges/>

113c. Double-acting continuous hinge

KG202 Swing Hinge

Kingsway Group USA
 2807 Samoset Road
 Royal Oak, MI 48073
 800-783-7980
www.kingswaygroupusa.com

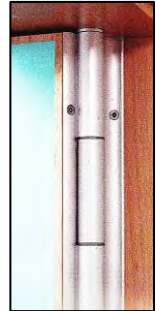

113d. Double-acting continuous hinge

KG280 Switch Hinge

Kingsway Group USA
 2807 Samoset Road
 Royal Oak, MI 48073
 800-783-7980
www.kingswaygroupusa.com

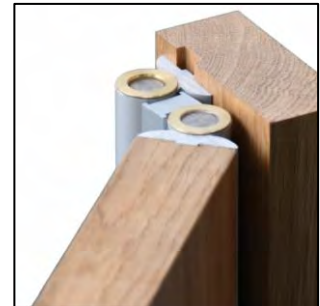

115b. Emergency stop

Emergency Release Stop - ERS

Pemko Manufacturing Company
 5535 Distribution Drive
 Memphis, TN 38141
 800-824-3018
www.pemko.com

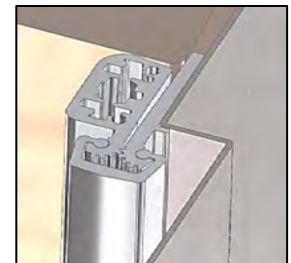
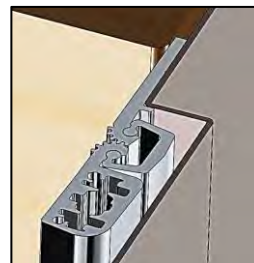
**PLEASE NOTE:**

Product information included in this document is intended for illustration of one or more specific items that are deemed appropriate for use in this type of facility. Comparable products by other manufacturers that meet the same design criteria may be substituted after careful comparison. No products are completely without risk. All product selections should be made in compliance with the findings of the comprehensive safety risk assessment for each location.

115c. Emergency stop

LG205, LG206 Swing Stop

Kingsway Group USA
2807 Samoset Road
Royal Oak, MI 48073
800-783-7980

www.kingswaygroupusa.com



120. Door pull

VR910-DT Vandal-Resistant Door Pull Trim

Ives
2720 Tobey Dr.
Indianapolis, IN 46219
877-671-7011

<http://us.allegion.com>



121c. Door pull, recessed

D89 Heavy Duty Security Flush Pull

Rockwood Manufacturing Company
300 Main Street
Rockwood, PA 15557
800-458-2424

www.rockwoodmfg.com



121d. Door pull, recessed

BF97L Heavy Duty ADA Security Flush Pull

Rockwood Manufacturing Company
300 Main Street
Rockwood, PA 15557
800-458-2424

www.rockwoodmfg.com

**PLEASE NOTE:**

Product information included in this document is intended for illustration of one or more specific items that are deemed appropriate for use in this type of facility. Comparable products by other manufacturers that meet the same design criteria may be substituted after careful comparison. No products are completely without risk. All product selections should be made in compliance with the findings of the comprehensive safety risk assessment for each location.

130a. Ligature-resistant lever handle lockset

SPSL Anti Ligature Lockset

Best Access Systems
6161 East 75th Street
Indianapolis, IN 46250
317-849-2250

<http://www.bestaccess.com/index.php/products/behavioral-health-products/>



130b. Ligature-resistant lever handle lockset

MRXLGrade 1 Mortise Lock with Ligature-Resistant Escutcheon

Townsteel, Inc.
17901 Railroad Street
City of Industry, CA 91748
877-858-0888

www.townsteel.com



130c. Ligature-resistant lever handle lockset

Schlage L Series Extra Heavy Duty Mortise Lock with ligature resistant lever

Allegion
877-671-7011

<http://us.allegion.com/IRSTDocs/Brochure/106510.pdf>



130d. Ligature-resistant lever handle lockset

Series 5SS19 Institutional Life Safety Mortise Locksets - Levers

Marks USA
365 Bayview Avenue
Amityville, NY 11701
800-526-0233

www.marksusa.com

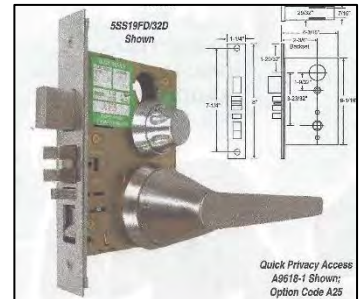

130e. Ligature-resistant lever handle lockset

LSL Life Safety Lever Series

Grainger
 100 Grainger Parkway
 Lake Forest, IL 60045
 800-472-4643
www.grainger.com

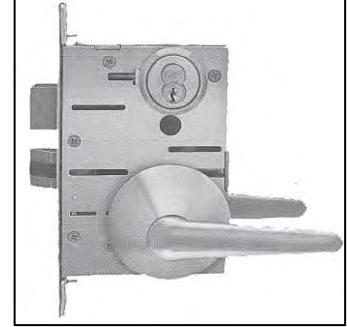

131a. Ligature-resistant modified lever handle lockset

8200 with BHW Trim

Sargent Manufacturing Company
 100 Sargent Drive
 P. O. Box 9725
 New Haven, CT 06536-0915
 800-727-5477
www.sargentlock.com



131b. Ligature-resistant modified lever handle lockset

Crescent Handle – horizontal installation

Accurate Lock and Hardware
 1 Annie Place
 Stamford, CT 06902
 203-348-8865
www accuratelockandhardware.com



131c. Ligature-resistant modified lever handle lockset

Securitech; Solis handle available for both mortise and cylindrical locksets)

Securitech Group, Inc.
 54-60 46th Street
 Maspeth, NY 11378
 800-622-5625
<http://www.securitech.com/securiguard/>

**PLEASE NOTE:**

Product information included in this document is intended for illustration of one or more specific items that are deemed appropriate for use in this type of facility. Comparable products by other manufacturers that meet the same design criteria may be substituted after careful comparison. No products are completely without risk. All product selections should be made in compliance with the findings of the comprehensive safety risk assessment for each location.

131d. Ligature-resistant modified lever handle lockset
HD Ligature Resistant Cylindrical Lock CH-CYL Series

Accurate Lock and Hardware

1 Annie Place

Stamford, CT 06902

203-348-8865

www accuratelockandhardware.com



132a. Ligature-resistant lockset

Ligature Resistant Push/Pull 9125ALP

Accurate Lock and Hardware

1 Annie Place

Stamford, CT 06902

203-348-8865

www accuratelockandhardware.com

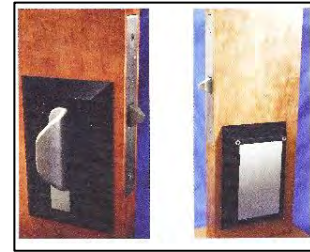

132b. Ligature-resistant modified lever handle lockset

8200 Mortise Lock with Push/Pull Trim (ALP)

SARGENT® Manufacturing Company

100 Sargent Drive

P. O. Box 9725

New Haven, CT 06536-0915

800-727-5477

www.sargentlock.com



140. Patient room privacy lockset

Patient Room Privacy Lockset

Best Access Systems

6161 East 75th Street

Indianapolis, IN 46250

800-392-5209

<http://www.bestaccess.com/products/behavioral-health-products/>



PLEASE NOTE:

Product information included in this document is intended for illustration of one or more specific items that are deemed appropriate for use in this type of facility. Comparable products by other manufacturers that meet the same design criteria may be substituted after careful comparison. No products are completely without risk. All product selections should be made in compliance with the findings of the comprehensive safety risk assessment for each location.

141a. Cylinder protector

Securiguard Cylinder Protector; Model #63LR

Securitech Group, Inc.

54-60 46th Street

Maspeth, NY 11378

800-622-5625

<http://www.securitech.com/securiguard/>

141b. Cylinder protector

ShieldX Cylinder Protector

Grainger

100 Grainger Parkway

Lake Forest, IL 60045

800-472-4643

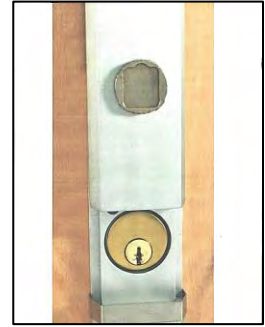
www.grainger.com

143. Deadbolt

Deadbolt #PBL102-630 with ligature-resistant turn piece (retract bolt only)

Securitech Group, Inc.

54-60 46th Street

Maspeth, NY 11378

800-622-5625

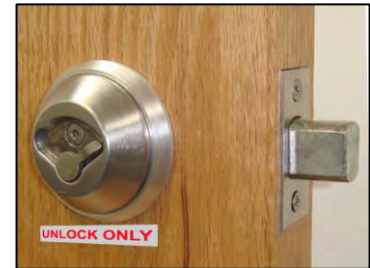
www.securitech.com

144. Sallyport interlock hardware

RACHIE™ series lockset package

Securitech Group, Inc.

54-60 46th Street

Maspeth, NY 11378

800-622-5625

www.securitech.com

146. Remote authorization

Assa Cliq Remote Authorization System

Assa Abloy

www.assaabloy.com**PLEASE NOTE:**

Product information included in this document is intended for illustration of one or more specific items that are deemed appropriate for use in this type of facility. Comparable products by other manufacturers that meet the same design criteria may be substituted after careful comparison. No products are completely without risk. All product selections should be made in compliance with the findings of the comprehensive safety risk assessment for each location.

146. Ball catch

347 Dual Adjustable Ball Catch

Ives
 2720 Tobey Dr.
 Indianapolis, IN 46219
 877-671-7011
<http://us.allegion.com>



147. Roller latch

RL30 Roller Latch

Ives
 2720 Tobey Dr.
 Indianapolis, IN 46219
 877-671-7011
<http://us.allegion.com>



148. Magnetic latch

327 Super-Mite Heavy Duty Magnetic Catch

Ives
 2720 Tobey Dr.
 Indianapolis, IN 46219
 877-671-7011
<http://us.allegion.com>



150a. Over-door alarm

The Door Switch

11772 Westline Industrial Drive
 St. Louis, MO 63146
 877-998-5625
<http://thedoorswitch.com>



150b. Over-door alarm

Top Door Alarm®

Door Control Services, Inc.
 321 VZ County Road 4500
 Ben Wheeler, TX 75754
 800-356-2025
www.doorcontrolservices.com

**PLEASE NOTE:**

Product information included in this document is intended for illustration of one or more specific items that are deemed appropriate for use in this type of facility. Comparable products by other manufacturers that meet the same design criteria may be substituted after careful comparison. No products are completely without risk. All product selections should be made in compliance with the findings of the comprehensive safety risk assessment for each location.

150c. Over-door alarm

Best; SEDA Door Alarm

Best Access Solutions, Inc.
6161 East 75th Street
Indianapolis, IN 46250

<http://www.bestaccess.com/products/behavioral-health-products/>

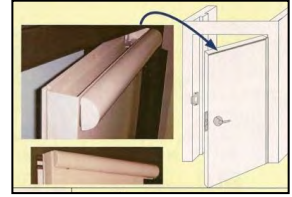

150d. Over-door alarm

LISA-Kit (Life Safety Alarm)

Grainger
100 Grainger Parkway
Lake Forest, IL 60045
800-472-4643

www.grainger.com

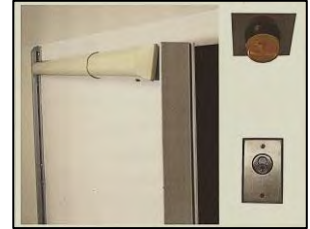

155. Sliding Door: Ligature-resistant

Ligature Resistant Sliding Door System

Accurate Lock and Hardware
1 Annie Place
Stamford, CT 06902
203-348-8865

www accuratelockandhardware.com

**PLEASE NOTE:**

Product information included in this document is intended for illustration of one or more specific items that are deemed appropriate for use in this type of facility. Comparable products by other manufacturers that meet the same design criteria may be substituted after careful comparison. No products are completely without risk. All product selections should be made in compliance with the findings of the comprehensive safety risk assessment for each location.

160a. Seclusion room door locks

Seclusion Room Time-Out Lock (surface mount)

Securitech
 54-45 44th Street
 Maspeth, NY 11378
 800-622-5625
www.securitech.com



160b. Seclusion room door locks

Multi-Point Deadbolt Mortise Lock (concealed mount)

Securitech
 54-45 44th Street
 Maspeth, NY 11378
 800-622-5625
www.securitech.com



160c. Seclusion room door locks

Schlage; LM9000 Multipoint Solution

Ingersoll Rand Security Technologies
 11819 N. Pennsylvania Street
 Carmel, IN 46032 US
 877-671-7011
<http://us.allegion.com/IRSTDocuments1/104833.pdf>



161. Cross-corridor door locks

#109 Electra Concealed Vertical Rod Latching Lever Locksets

Securitech
 54-45 44th Street
 Maspeth, NY 11378
 800-622-5625
www.securitech.com

PLEASE NOTE:

Product information included in this document is intended for illustration of one or more specific items that are deemed appropriate for use in this type of facility. Comparable products by other manufacturers that meet the same design criteria may be substituted after careful comparison. No products are completely without risk. All product selections should be made in compliance with the findings of the comprehensive safety risk assessment for each location.

162. Elopement buffer or sallyport door locks

RACHIE Entry & Exit Control Systems

Securitech
 54-45 44th Street
 Maspeth, NY 11378
 800-622-5625
www.securitech.com



175a. Wall Stops

KG184 Anti-Ligature Rubber Wall Stop

Kingsway Group USA
 2807 Samoset Road, Suite 200
 Royal Oak, MI 48073
 800-783-7980
www.kingswaygroupusa.com



175b. Wall Stops

KG270-278 Anti-Ligature Extended Rubber Wall Stop

Kingsway Group USA
 2807 Samoset Road, Suite 200
 Royal Oak, MI 48073
 800-783-7980
www.kingswaygroupusa.com

**08 87 53 - SECURITY FILMS**

190a. Window film

Scotchshield™ Ultra – 14 mil Film with Perimeter Attachment System

3M Specified Construction Products Department
 3M Center
 St. Paul, MN 55144
 888-364-3577
www.3m.com

190b. Window film

200 Series – Safety and Security Laminate

ACE (Advanced Coatings Engineering)
 2915 Ogletown Road
 Newark, DE 19713
 888-607-0000
www.usace.com

PLEASE NOTE:

Product information included in this document is intended for illustration of one or more specific items that are deemed appropriate for use in this type of facility. Comparable products by other manufacturers that meet the same design criteria may be substituted after careful comparison. No products are completely without risk. All product selections should be made in compliance with the findings of the comprehensive safety risk assessment for each location.

08 88 53 - SECURITY GLAZING

200a. Security glazing

121000 or 121100 ArmorProtect Plus®

Oldcastle BuildingEnvelope®
5005 LBJ Freeway, Suite 1050
Dallas, TX 75244
866-653-2278
www.obe.com



200b. Security glazing

9/16Psych-2118

Global Security Glazing
616 Selfield Road
Selma, AL 36703
(800) 633-2513
www.security-glazing.com

201a. Polycarbonate sheet glazing – abrasion-resistant

MR10 LEXAN™ MARGARD™ II Sheet

SABIC Americas
One Plastics Avenue
Pittsfield, MA 01201
800-323-3783
www.sabic.com

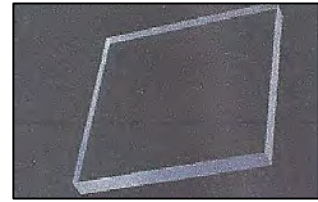

201b. Polycarbonate sheet glazing

Makrolon® GP Sheet

Covestro LLC
1 Covestro Circle
Pittsburgh, PA 15205-9723
877-229-3778
www.sheets.covestro.com

PLEASE NOTE:

Product information included in this document is intended for illustration of one or more specific items that are deemed appropriate for use in this type of facility. Comparable products by other manufacturers that meet the same design criteria may be substituted after careful comparison. No products are completely without risk. All product selections should be made in compliance with the findings of the comprehensive safety risk assessment for each location.

205a. Fire-rated glazing

SaftiFirst – SuperLite

O’Keeffe’s, Inc. SaftiFirst
 100 N. Hill Dr. #12
 Brisbane, CA 94005
 888-653-3333
www.safti.com

220a. Vision panels

Vision panels, key operation

VISTAMATIC®
 11713 NW 39th Street
 Coral Springs, FL 33065
 866-466-9525
www.vistamaticvisionpanels.com



220b. Wall Stops

Duralux Secure Privacy Vision Panel

Kingsway Group USA
 2807 Samoset Road, Suite 200
 Royal Oak, MI 48073
 800-783-7980
www.kingswaygroupusa.com



220c. Vision panels

Fixed or motorized louvers inside glass panels

Unicel Architectural Corp.
 2155 Fernand Lafontaine Blvd.
 Longueuil, Quebec, Canada J4G 2J4
 800-668-1580
www.unicelarchitectural.com

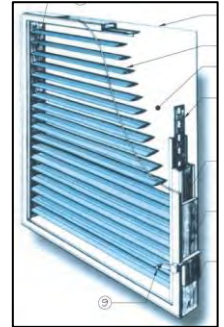

220d. Vision panels

Between Glass Blinds vision panels

VISTAMATIC, LLC
 11713 NW 39th Street
 Coral Springs, FL 33065
 866-466-9525
www.betweenglassblinds.com

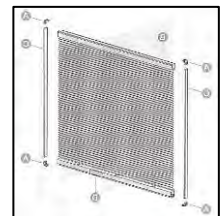
**PLEASE NOTE:**

Product information included in this document is intended for illustration of one or more specific items that are deemed appropriate for use in this type of facility. Comparable products by other manufacturers that meet the same design criteria may be substituted after careful comparison. No products are completely without risk. All product selections should be made in compliance with the findings of the comprehensive safety risk assessment for each location.

220e. Vision panels

IE; Blinds® sealed, integral blind assemblies

IE Blinds
 P.O. Box 442
 Ben Wheeler, TX 75754
 866-267-1917
www.ieblinds.com



221a. Vision panels

Clarity Privacy Glass (electric)

VISTAMATIC®
 11713 NW 39th Street
 Coral Springs, FL 33065
 866-466-9525
www.vistamaticvisionpanels.com



221b. Vision Panels

Duralux Platinum Switchable Vision Panel (electric)

Kingsway Group USA
 2807 Samoset Road, Suite 200
 Royal Oak, MI 48073
 800-783-7980
www.kingswaygroupusa.com

**09 00 00 - FINISHES****09 21 16 - GYPSUM BOARD**

230a. Impact-resistant gypsum board

Sheetrock® Brand engineered gypsum panels – abuse-resistant

USG Corporation
 550 West Adams Street
 Chicago, IL 60661
 800-874-4968
www.usg.com

PLEASE NOTE:

Product information included in this document is intended for illustration of one or more specific items that are deemed appropriate for use in this type of facility. Comparable products by other manufacturers that meet the same design criteria may be substituted after careful comparison. No products are completely without risk. All product selections should be made in compliance with the findings of the comprehensive safety risk assessment for each location.

230b. Impact-resistant wallboard

Gold Bond® Brand Hi-Impact® XP® Gypsum Board – moisture- and fire-resistant

National Gypsum Company
2001 Rexford Road
Charlotte, NC 28211
704-365-7300
www.nationalgypsum.com

230c. Impact-resistant wallboard

Extreme Impact Resistant Type X Gypsum Board

CertainTeed Corporation
20 Moores Road
Melvern, PA 19355
800-233-8990
www.certainteed.com

231a. Abrasion-resistant wallboard

Gold Bond® Brand Hi-Abuse® XP® Gypsum Board

National Gypsum Company
2001 Rexford Road
Charlotte, NC 28211
704-365-7300
www.nationalgypsum.com

231b. Abrasion-resistant wallboard

Extreme Abuse Resistant Type X Gypsum Board

CertainTeed Corporation
20 Moores Road
Melvern, PA 19355
800-233-8990
www.certainteed.com

PLEASE NOTE:

Product information included in this document is intended for illustration of one or more specific items that are deemed appropriate for use in this type of facility. Comparable products by other manufacturers that meet the same design criteria may be substituted after careful comparison. No products are completely without risk. [All product selections should be made in compliance with the findings of the comprehensive safety risk assessment for each location.](#)

232a. Sound-absorbing wallboard

QuietRock sound-reducing panels

PABCO® Gypsum
37851 Cherry Street
Newark, CA 94560
800-797-8159

www.quietrock.com

232b. Sound-absorbing wallboard

Silent FX Quick Cut Noise Reducing Type X Gypsum Board

CertainTeed Corporation
20 Moores Road
Melvern, PA 19355
800-233-8990

www.certainteed.com

238. Ceiling Accessories

Armstrong Ceilings; MBAC – Main Beam Adapter Clip

Armstrong Ceiling Solutions
877-276-7876

www.armstrongceilings.com/

09 50 00 - CEILINGS

239. Tamper-resistant ceiling panels

Armstrong Ceilings; Metal Works Vector

Armstrong Ceiling Solutions
877-276-7876

www.armstrongceilings.com/

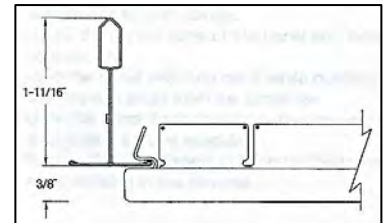

09 65 13 - RESILIENT BASE

240. Wall base

Health Design™ Wall Base

FLEXCO® Corporation
1401 East 6th Street
Tuscumbia, AL 35674
800-633-3151



PLEASE NOTE:

Product information included in this document is intended for illustration of one or more specific items that are deemed appropriate for use in this type of facility. Comparable products by other manufacturers that meet the same design criteria may be substituted after careful comparison. No products are completely without risk. All product selections should be made in compliance with the findings of the comprehensive safety risk assessment for each location.

www.flexcofloors.com

241a. Wall base

Visuelle Wall Base

Roppe Corporation, USA
1602 North Union Street
Fostoria, OH 44830
800-537-9527
www.roppe.com



241b. Wall base

Johnsonite “Millwork” Contours Wall Base – PV4065

Roppe Corporation, USA
1602 North Union Street
Fostoria, OH 44830
800-537-9527
www.roppe.com

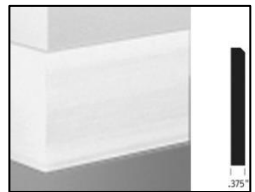

09 65 16 - RESILIENT FLOORING

245a. Sheet vinyl flooring

Homogeneous Vinyl Sheet Flooring

Armstrong Flooring, Inc.
P.O. Box 3025
Lancaster, PA 17604
888-276-7876
www.armstrong.com

245b. Sheet vinyl flooring

noraplan sheet flooring

nora® systems, Inc.
9 Northeastern Blvd.
Salem, NH 03079
800-332-NORA
www.nora.com/us

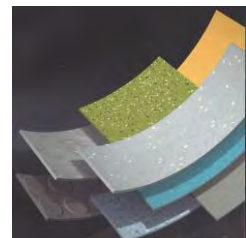

PLEASE NOTE:

Product information included in this document is intended for illustration of one or more specific items that are deemed appropriate for use in this type of facility. Comparable products by other manufacturers that meet the same design criteria may be substituted after careful comparison. No products are completely without risk. All product selections should be made in compliance with the findings of the comprehensive safety risk assessment for each location.

09 67 00 - FLUID-APPLIED FLOORING

250a. Seamless floors and base

Cheminert K flooring

Dex-O-Tex

Division of Crossfield Products Corp.

140 Valley Road

Roselle Park, NJ 07204

908-245-2800

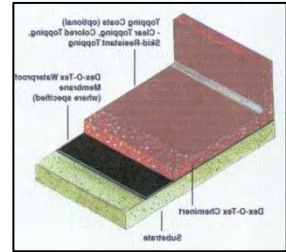
www.dexotex.com

250b. Seamless floors and base

Seamless flooring systems

Dur-A-Flex, Inc.

95 Goodwin Street

East Hartford, CT 06108

877-2 51-5418

www.dur-a-flex.com

250c. Seamless floors and base

Sika Corp.; Sikafloor – no top edge trim at integral base

Sika Corporation

201 Polito avenue

Lyndhurst, NJ 07071

800-933-7452

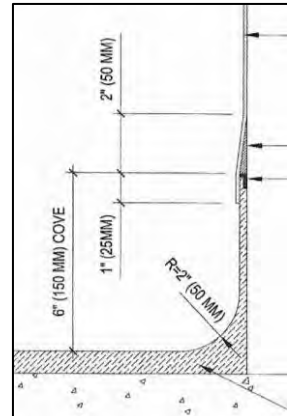
www.sikafloorusa.com**09 68 16 - SHEET CARPETING**

255. Carpet

Mohawk Group GL 182 Exotic Fauna Sheet Carpet with Unibond Plus Bloc backing

Mohawk Group

160 South Industrial Blvd.

Calhoun, GA 30701

800-554-6637

www.Mohawkgroup.com**PLEASE NOTE:**

Product information included in this document is intended for illustration of one or more specific items that are deemed appropriate for use in this type of facility. Comparable products by other manufacturers that meet the same design criteria may be substituted after careful comparison. No products are completely without risk. All product selections should be made in compliance with the findings of the comprehensive safety risk assessment for each location.

09 77 00 - SPECIAL WALL SURFACING

270a. Wall padding

Gold Medal Safety Padding®

Marathon Engineering Corporation
 5615 2nd Street West
 Lehigh Acres, FL 33913
 239-303-7378

<https://goldmedalsafetypadding.com>



270b. Wall padding

Surface padding systems

Padded Surfaces by B&E
 2339 Distributors Drive
 Indianapolis, IN 46241
 888-243-8788

<http://paddedsurfaces.com>

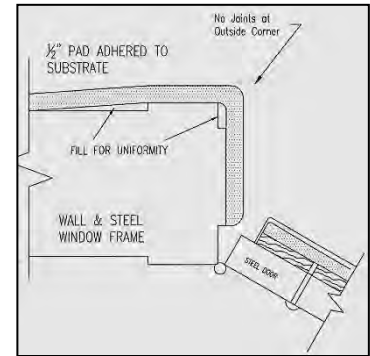

272. Seclusion room wall and floor material

Lonfloor Plain – smooth

Lonseal, Inc.
 928 East 238th Street
 Carson, CA 90745
 800-832-7111

www.lonseal.com

09 96 13 – ABRASION RESISTANT COATINGS

280. Wall finish (do not use on floors)

Sto; Decocoat®

Sto Americas
 3800 Camp Creek Parkway SW
 Building 1400, Suite 120
 Atlanta, GA 30331
 800-221-2397

www.stocorp.com

PLEASE NOTE:

Product information included in this document is intended for illustration of one or more specific items that are deemed appropriate for use in this type of facility. Comparable products by other manufacturers that meet the same design criteria may be substituted after careful comparison. No products are completely without risk. All product selections should be made in compliance with the findings of the comprehensive safety risk assessment for each location.

10 00 00 – SPECIALTIES

10 12 00 – DISPLAY CASES

290a. TV enclosure – suicide-resistant

TE450 Ligature-Resistant Protective TV Enclosure

Behavioral Safety Products
29A N. Main St., Suite 3
Watkinsville, GA 30677
706-705-1500
www.besafepro.com



290b. TV Enclosure – suicide resistant

Protective Enclosures, FPE55F(H)-S

Peerless A-V
2300 White Oak Circle
Aurora, IL 60502
800-865-2112
www.perlessmounts.com

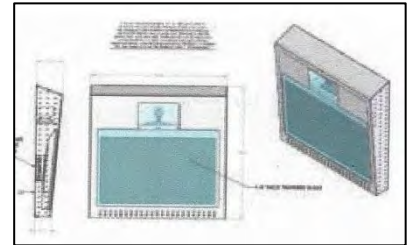

290c. TV enclosure – suicide-resistant

Ligature-resistant TV enclosure

ProEnc
101 Hudson Street
Jersey City, NJ 07302
862-234-5981
www.lcdtvenclosure.com

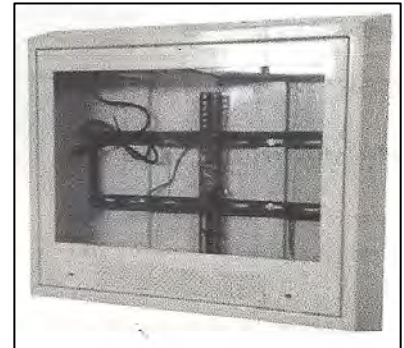

10 14 00 – SIGNAGE

300a. Room signs

Flxsigns

2/90 Sign Systems
5350 Corporate Grove Blvd. SE
Grand Rapids, MI 49512
800-777-4310



http://www.290signs.com/images/stories/pdf/Literature/FlxSignFlyer_7.14.pdf

PLEASE NOTE:

Product information included in this document is intended for illustration of one or more specific items that are deemed appropriate for use in this type of facility. Comparable products by other manufacturers that meet the same design criteria may be substituted after careful comparison. No products are completely without risk. All product selections should be made in compliance with the findings of the comprehensive safety risk assessment for each location.

300b. Room signs

Secure + spec

Creative Signage Systems, Inc.

9101 51st Place

College Park, MD 20740

800-220-7446

www.creativesignage.com**PLEASE NOTE:**

Product information included in this document is intended for illustration of one or more specific items that are deemed appropriate for use in this type of facility. Comparable products by other manufacturers that meet the same design criteria may be substituted after careful comparison. No products are completely without risk. [All product selections should be made in compliance with the findings of the comprehensive safety risk assessment for each location.](#)

300c. Room signs

KING KMS® Modular Sign System

King Architectural Products
31 Simpson Road
Bolton, ON, Canada, L7E 2R6
877-857-2804

www.kingarchitecturalproducts.com

**10 26 16.16 – PROTECTIVE CORRIDOR HANDRAILS**

330a. Corridor handrail

Acrovyn® ligature-resistant handrail with continuous aluminum mounting bracket

Construction Specialties
6696 State Road 405
Muncy, PA 17756
800-233-8493

www.c-sgroup.com

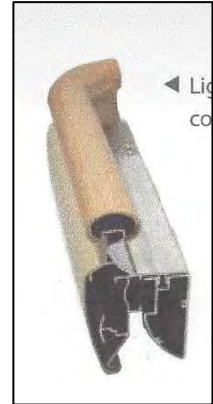
**10 26 23 – PROTECTIVE WALL COVERING**

320a. Synthetic wall protection

Avonite® Acrylic products - Wall Protection

Avonite
1945 Highway 304
Belen, NM 87002
800-4-AVONITE

www.avonitesurfaces.com

320b. Synthetic wall protection

Acrovyn by Design® Wall Protection

Construction Specialties
6696 State Road 405
Muncy, PA 17756
800-233-8493

www.c-sgroup.com

**PLEASE NOTE:**

Product information included in this document is intended for illustration of one or more specific items that are deemed appropriate for use in this type of facility. Comparable products by other manufacturers that meet the same design criteria may be substituted after careful comparison. No products are completely without risk. All product selections should be made in compliance with the findings of the comprehensive safety risk assessment for each location.

10 28 13 - SECURITY TOILET ACCESSORIES

332a. Grab bar

SAFEBAR® grab bar

Cascade Specialty Hardware, Inc.
1413 Lincoln Avenue
Vancouver, WA 98660
360-823-3995
www.cascadesh.com

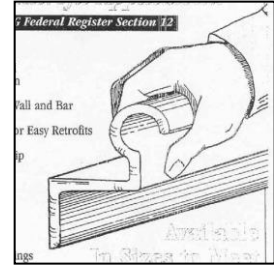

332b. Grab bar

811-S01 SafeSupport® Safe-T Grab Bar

Weizel Security
800-308-3627
<http://www.securingshospitals.com/>

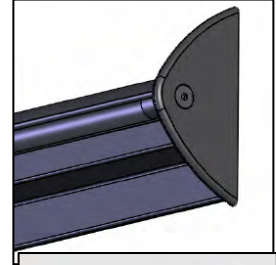

332c. Grab bar

NW SecurityBar®

Northwest Specialty Hardware, Inc.
15865 SE 114th Avenue, Suite C
Clackamas, OR 97015
503-557-1881
<http://www.northwestsh.com/>

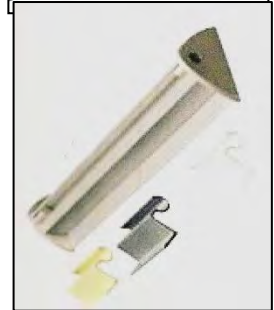

332d. Grab bar

KG270-278 Anti-Ligature Grab Bar

Kingsway Group USA
2807 Samoset Road, Suite 200
Royal Oak, MI 48073
800-783-7980
www.kingswaygroupusa.com

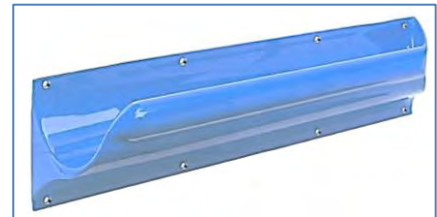

337. Grab bar – vertical

SP-3V Vertical Grab Bar

Odd Ball Industries
P.O. Box 376
Greenlawn, NY 11740
631-754-0400
www.oddballindustries.com



Cross-section

finished end

PLEASE NOTE:

Product information included in this document is intended for illustration of one or more specific items that are deemed appropriate for use in this type of facility. Comparable products by other manufacturers that meet the same design criteria may be substituted after careful comparison. No products are completely without risk. All product selections should be made in compliance with the findings of the comprehensive safety risk assessment for each location.

340. Paper towel dispenser

817-S45 SR™ Paper Towel Dispenser Cover

Weizel Security

800-308-3627

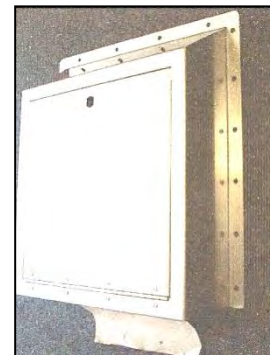
www.securingshospitals.com

340b. Paper towel dispenser

LG02 Paper Towel Dispenser

Kingsway Group USA

2807 Samoset Road, Suite 200

Royal Oak, MI 48073

800-783-7980

www.kingswaygroupusa.com

341. Roll Paper Towel Dispenser

Whitehall MFG.; Model WH1848B Roll Paper Towel Dispenser

Whitehall Manufacturing

P.O. Box 3257

City of Industry, CA 91744

1-800-782-7706

www.whitehallmfg.com

350a. Robe hook – break-away

Odd Ball Industries; SP6 Robe/Towel Hook

Odd Ball Industries Mfg. Co., Inc.

P.O. Box 376

Greenlawn, NY 11740

1-631-754-0400

<http://www.oddballindustries.com>**PLEASE NOTE:**

Product information included in this document is intended for illustration of one or more specific items that are deemed appropriate for use in this type of facility. Comparable products by other manufacturers that meet the same design criteria may be substituted after careful comparison. No products are completely without risk. All product selections should be made in compliance with the findings of the comprehensive safety risk assessment for each location.

350b. Robe hook – break-away

Weizel Security; SR813-S08 SafeSupport SR Collapsible Towel Hook

Weizel Security
800-308-3627

<http://www.securingshospitals.com/>

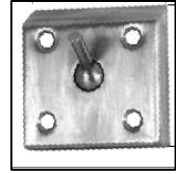

350c. Robe hook – break-away

Bradley Corporation – B983 Vandal Resistant Clothes Hook

Bradley Corporation
PO. Box 309
Menomonee Falls, WI 53052
1-800-BRADLEY

<http://www.bradleycorp.com>



350d. Robe hook – break-away

Northwest Specialty Hardware, Inc.; Clothes Hook #NW 608

Northwest Specialty Hardware, Inc.
15865 SE 1143th Avenue, Suite C
Clackamas, OR 97015
503-557-1881

<http://www.northwestsh.com/>



350e. Robe hook – breakaway

KG180 Logica Coat Hook

Kingsway Group USA
2807 Samoset Road, Suite 200
Royal Oak, MI 48073
800-783-7980

www.kingswaygroupusa.com



360a. Security Mirrors

RAO Contract Sales Hybrid Safety Mirror in Guardian Frame

RAO Contract Sales, Inc.
392 Atwood Place
Wyckoff, NJ 07481
800-445-7065

www.rao.com



PLEASE NOTE:

Product information included in this document is intended for illustration of one or more specific items that are deemed appropriate for use in this type of facility. Comparable products by other manufacturers that meet the same design criteria may be substituted after careful comparison. No products are completely without risk. All product selections should be made in compliance with the findings of the comprehensive safety risk assessment for each location.

360b. Security Mirrors

ROVAL™ stainless steel mirror #20650-B

American Specialties, Inc.
 441 Saw Mill River Road
 Yonkers, NY 10701
 914-476-9000
www.americanspecialties.com



360c. Security Mirrors

McGrory Glass Security mirror JOC-161

McGrory Glass Inc.
 1400 Grandview Avenue
 Paulsboro, NJ 08066
 856-579-3200
www.mcgrory-glass.com

361a. Mirror guard

SP-8 Mirror Guard

Odd Ball Industries
 P.O. Box 376
 Greenlawn, NY 11740
 631-754-0400
www.oddballindustries.com



370c. Recessed shelf

WH1820FA BestCare® Recessed Shelf (front mount through flange)

Whitehall Manufacturing
 P.O. Box 3527
 City of Industry, CA 91744-0527
 800-782-7706
www.whitehallmfg.com

**PLEASE NOTE:**

Product information included in this document is intended for illustration of one or more specific items that are deemed appropriate for use in this type of facility. Comparable products by other manufacturers that meet the same design criteria may be substituted after careful comparison. No products are completely without risk. All product selections should be made in compliance with the findings of the comprehensive safety risk assessment for each location.

370d. Recessed shelf

American Specialties, Inc.; Model 412 (front mount through side)

American Specialties, Inc.
441 Saw Mill River Road
Yonkers, NY 10701
914-476-9000

<http://www.americanspecialties.com/>



371c. Shelf – surface-mounted

SA56 Bookshelf

Bradley Corporation
W142N9101 Fountain Boulevard
Menomonee Falls, WI 53051
800-272-3539

www.bradleycorp.com



380a. Shower seat

ADA Shower Seat

Norix Group, Inc.
1800 W. Hawthorne Lane, Suite N
West Chicago, IL 60185
800-234-4900

www.norix.com



380b. Shower seat

ADA Shower Seat

Brey-Krause Manufacturing Co.
1209 W. Lehigh Street
Bethlehem, PA 18018
610-867-1401

www.breykrause.com

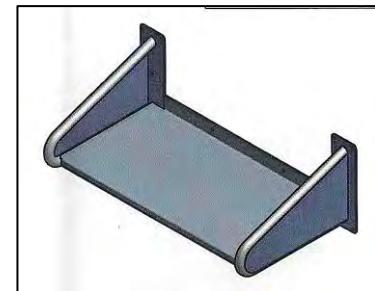
**PLEASE NOTE:**

Product information included in this document is intended for illustration of one or more specific items that are deemed appropriate for use in this type of facility. Comparable products by other manufacturers that meet the same design criteria may be substituted after careful comparison. No products are completely without risk. All product selections should be made in compliance with the findings of the comprehensive safety risk assessment for each location.

390a. Soap Dish

Whitehall Manufacturing; Bestcare Bathroom Accessory Solutions Model Number WH1832-PF (front mount with plaster flange)

Whitehall Manufacturing
P.O. Box 3257
City of Industry, CA 91744
1-800-782-7706
www.whitehallmfg.com



390b. Soap dish

Norix Group Inc.; Recessed Soap Dish (rear mount)

Norix Group, Inc.
1000 Atlantic Drive
West Chicago, IL 60185
1-800-234-4900
<http://www.norix.com>

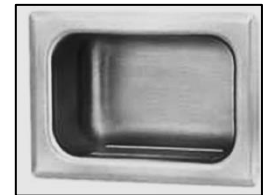

391a. Soap dispenser

KG08 Manual Soap Dispenser – Gojo Compatible

Kingsway Group USA
2807 Samoset Road, Suite 200
Royal Oak, MI 48073
800-783-7980
www.kingswaygroupusa.com



391b. Soap dispenser

ADX-12™ Security Enclosure

GOJO Industries, Inc.
One GOJO Plaza, Suite 500
Akron, OH 44309
800-321-9647
www.gojo.com

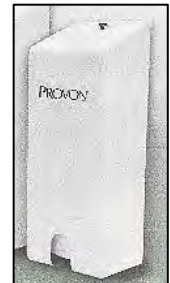
**PLEASE NOTE:**

Product information included in this document is intended for illustration of one or more specific items that are deemed appropriate for use in this type of facility. Comparable products by other manufacturers that meet the same design criteria may be substituted after careful comparison. No products are completely without risk. All product selections should be made in compliance with the findings of the comprehensive safety risk assessment for each location.

391c. Soap dispenser

OPS® 1-Touch™ Foaming Hand Soap Dispenser – ligature-resistant

Archer Manufacturing
Danville, CA
800-796-5545
www.vandalproof.org



391d. Soap dispenser

Suicide Prevention Soap Dispenser

Norva Plastics, Inc.
3911 Killam Ave.
Norfolk, VA 23508
800-826-0758
www.norvaplastics.com

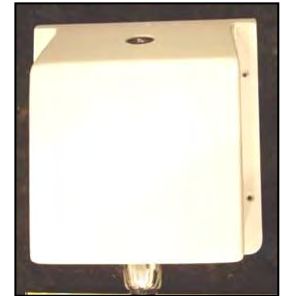

400a. Toilet paper holder

KG13 Toilet Roll Holder

Kingsway Group USA
2807 Samoset Road, Suite 200
Royal Oak, MI 48073
800-783-7980
www.kingswaygroupusa.com

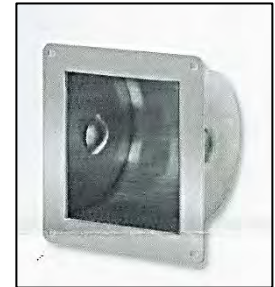

400b. Toilet paper holder

Whitehall MFG; Model WH1847B Series Toilet Roll Holder

Recessed model (1845B) also available

Whitehall Manufacturing
P.O. Box 3257
City of Industry, CA 91744
1-800-782-7706
www.whitehallmfg.com



PLEASE NOTE:

Product information included in this document is intended for illustration of one or more specific items that are deemed appropriate for use in this type of facility. Comparable products by other manufacturers that meet the same design criteria may be substituted after careful comparison. No products are completely without risk. All product selections should be made in compliance with the findings of the comprehensive safety risk assessment for each location.

400c Toilet paper holder

KG03 Surface Mount Toilet Roll Holder

Kingsway Group USA
2807 Samoset Road, Suite 200
Royal Oak, MI 48073
800-783-7980
www.kingswaygroupusa.com



400f. Toilet paper holder

C-400 Safety Toilet Paper Holder

Cascade Specialty Hardware, Inc.
1413 Lincoln Avenue
Vancouver, WA 98660
360-823-3995
www.cascadesh.com



400g. Toilet paper holder

WH1845A BestCare® Recessed Auto-Release Toilet Paper Holder – front mount

Whitehall Manufacturing
P.O. Box 3527
City of Industry, CA 91744-0527
800-782-7706
www.whitehallmfg.com



400h. Toilet paper holder

Suicide-Resistant Toilet Paper Dispenser

Norva Plastics, Inc.
3911 Killam Ave.
Norfolk, VA 23508
800-826-0758
www.norvaplastics.com

***PLEASE NOTE:***

Product information included in this document is intended for illustration of one or more specific items that are deemed appropriate for use in this type of facility. Comparable products by other manufacturers that meet the same design criteria may be substituted after careful comparison. No products are completely without risk. All product selections should be made in compliance with the findings of the comprehensive safety risk assessment for each location.

410a. Undersink protection

Truebro® Lav Shield®

IPS® Corporation
 455 W. Victoria Street
 Compton, CA 90220
 310-898-3300
www.truebro.com



410b. Undersink protection

831-S27 SR™ Undersink Enclosure

Weizel Security
 800-308-3627
www.securingshospitals.com

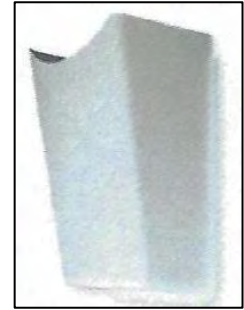
**10 86 00 – SECURITY MIRRORS AND DOMES**

420a. Convex mirrors

DuraVision Quarter Dome Mirror

Norix Group, Inc.
 1800 W. Hawthorne Lane, Suite N
 West Chicago, IL 60185
 800-234-4900
www.norix.com

**12 00 00 - FURNISHINGS****12 21 13 – HORIZONTAL LOUVER BLINDS**

430a. Aluminum window with integral blind

2450 Series Storefront with hinged sash and integral blind

Manko Window Systems, Inc.
 800 Hayes Drive
 Manhattan, KS 66502
 800-642-1488
www.mankowindows.com

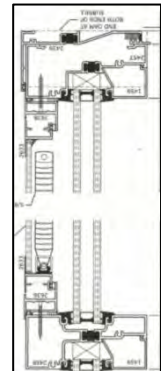
**PLEASE NOTE:**

Product information included in this document is intended for illustration of one or more specific items that are deemed appropriate for use in this type of facility. Comparable products by other manufacturers that meet the same design criteria may be substituted after careful comparison. No products are completely without risk. All product selections should be made in compliance with the findings of the comprehensive safety risk assessment for each location.

430b. Aluminum window with integral blind

2187-DT Psychiatric Windows with integral blind

Wausau Window and Wall Systems

7800 International Drive

Wausau, WI 54401

877-678-2983

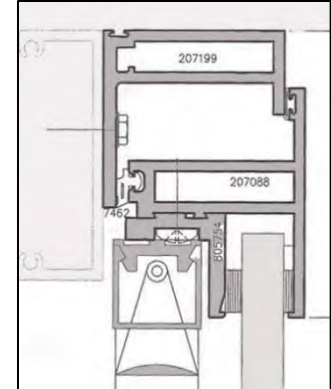
www.wausauwindow.com

430c. Aluminum window with integral blind - removable

SS-5100 Medium-Security Mental Health Security Window

Sherwood Windows Group

37 Iron Street

Toronto, Ontario M9W 5E3

Canada

800-770- 5256

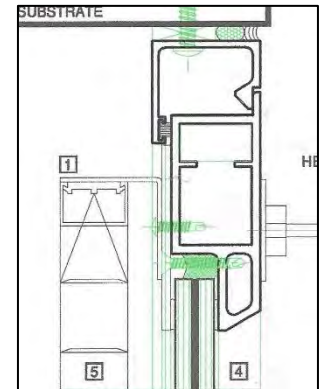
www.sherwoodwindows.com

434a. Exterior windows - ventilation

Safevent Windows

Britplas

Unit 18 Kingsland Grange

Woolston, Warrington WA1 4RW

England

+44-1925-824317

www.britplas.com**PLEASE NOTE:**

Product information included in this document is intended for illustration of one or more specific items that are deemed appropriate for use in this type of facility. Comparable products by other manufacturers that meet the same design criteria may be substituted after careful comparison. No products are completely without risk. All product selections should be made in compliance with the findings of the comprehensive safety risk assessment for each location.

434b. Exterior windows - ventilation

SW-6300 Operable Security Window

Sherwood Windows Group
37 Iron Street
Toronto, Ontario M9W 5E3
Canada
800-770-5256
www.sherwoodwindows.com



434c. Exterior windows - ventilation

512 Ventrow Ventilator

Kawneer North America
Technology Park / Atlanta
555 Guthridge Court
Norcross, GA 30092
770-449-5555
www.kawneer.com

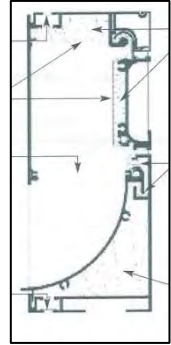
**12 21 33 – ROLL-DOWN BLINDS**

440a. Roller blinds

Webb Lok cordless roller shades

Inpro
S80 W18766 Apollo Drive
Muskego, WI 53150
800-222-5556
<https://www.inprocorp.com/clickeze-privacy-systems/specialty-window-shades>

**12 35 70 – HEALTHCARE CASE WORK**

460a. Cabinet pulls

DP74C Cabinet Pull

Doug Mockett & Company, Inc.
1915 Abalone Ave.
Torrance, CA 90501
800-523-1269
www.mockett.com

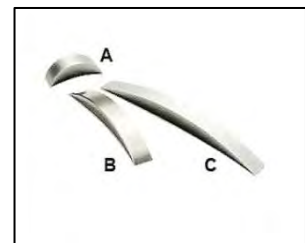
**PLEASE NOTE:**

Product information included in this document is intended for illustration of one or more specific items that are deemed appropriate for use in this type of facility. Comparable products by other manufacturers that meet the same design criteria may be substituted after careful comparison. No products are completely without risk. All product selections should be made in compliance with the findings of the comprehensive safety risk assessment for each location.

460b. Cabinet pulls

UT-105/S Pressure Fit Recess Pull

Sugatsune America, Inc.
 18101 Savarona Way
 Carson, CA 90746
 800-562-5267
www.sugatsune.com



460c. Cabinet pulls

Top Knobs – Mayfair Cup Pull attached with tamper-resistant fasteners

My Knobs.com
 485 S. Broadway
 Hicksville, NY 11801
 866-695-6627
www.myknobs.com



460d. Cabinet pulls

104.66.200 Zinc Handle – polished chrome finish

Hafele America Co.
 3901 Cheyenne Drive
 Archdale, NC 27263
 800-423-3531
www.hafele.com/us/en



465a. Cabinet locks – keyless

300 Series eLock®: Cabinet version

CompX Security Products
 715 Center Street
 Grayslake, IL 60030
 847-752-2500
www.compxelock.com

**PLEASE NOTE:**

Product information included in this document is intended for illustration of one or more specific items that are deemed appropriate for use in this type of facility. Comparable products by other manufacturers that meet the same design criteria may be substituted after careful comparison. No products are completely without risk. All product selections should be made in compliance with the findings of the comprehensive safety risk assessment for each location.

465b. Cabinet locks – keyless
dialock

Hafele America Co.
3901 Cheyenne Drive
Archdale, NC 27263
800-423-3531
www.hafele.com/us/en

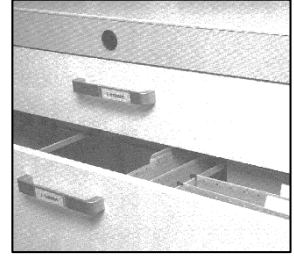

465c. Cabinet locks – keyless

100 Series eLock: Cabinet Version

CompX Security Products
P. O. Box 200
Mauldin, SC 29662
864-297-6655
www.compxelock.com

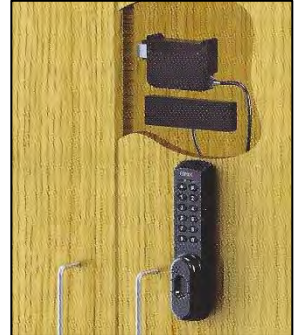

470a. Tamper-resistant screws

Tamperproof screws

Tamperproof Screw Company, Inc.
30 Laurel Street
Hicksville, NY 11801
516-931-1616
www.tamperproof.com



470b. Tamper-resistant screws

Security Pin Torx Screws and Bits

Northwest Specialty Hardware, Inc.
15865 SE 114th Avenue, Suite C
Clackamas, OR 97015
503-557-1881
www.northwestsh.com



PLEASE NOTE:

Product information included in this document is intended for illustration of one or more specific items that are deemed appropriate for use in this type of facility. Comparable products by other manufacturers that meet the same design criteria may be substituted after careful comparison. No products are completely without risk. [All product selections should be made in compliance with the findings of the comprehensive safety risk assessment for each location.](#)

12 44 16 – SHOWER DOORS

473a. Shower doors

Sentinel Event Reduction Shower Door

Norva Plastics, Inc.

3911 Killam Ave.

Norfolk, VA 23508

800-826-0758

www.norvaplastics.com

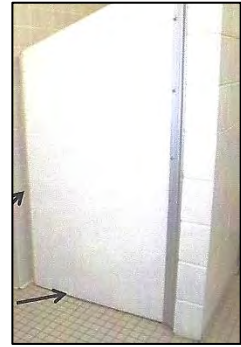

473b. Patient toilet door

Soft Suicide Prevention Door

Kennon Products, Inc.

2071 North Main Street

Sheridan, WY 82801

307-674-6498

www.suicideproofing.com



PLEASE NOTE:

Product information included in this document is intended for illustration of one or more specific items that are deemed appropriate for use in this type of facility. Comparable products by other manufacturers that meet the same design criteria may be substituted after careful comparison. No products are completely without risk. [All product selections should be made in compliance with the findings of the comprehensive safety risk assessment for each location.](#)

12 46 23 – DECORATIVE CRAFTS

475. Vinyl artwork

Soft Suicide Prevention Artwork (SSPA)

Kennon Products, Inc.

2071 N. Main Street

Sheridan, WY 82801

307-674-6498

www.suicideproofing.com



476a. Ligature-resistant frames

Solid surface frames

Custom Design Frameworks

3998 Fox Hunter Lane

Mechanicsville, VA 23111

804-476-4233

www.customdesignframeworks.com



476b. Ligature-resistant frames

AF550 Ligature-Resistant Art Frame

Behavioral Safety Products

29A N. Main St., Suite 3

Watkinsville, GA 30677

706-705-1500

www.besafepro.com



476c. Display boards

Tak-Les Bulletin Board with Guardian Frame

RAO Contract Sales, Inc.

94 Fulton Street

Paterson, NJ 07501

800-445-7065

www.rao.com

PLEASE NOTE:

Product information included in this document is intended for illustration of one or more specific items that are deemed appropriate for use in this type of facility. Comparable products by other manufacturers that meet the same design criteria may be substituted after careful comparison. No products are completely without risk. [All product selections should be made in compliance with the findings of the comprehensive safety risk assessment for each location.](#)

12 52 70 - HEALTHCARE SEATING

479a. Stools

OFS Brands; Boost Ottoman

OFS Brands
1204 East Sixth Street
Huntingburg, IN 47542
800-521-5381
www.info@ofsbrands.com



479b. Stools

Norix: Slammer Stool Series

Norix Group, Inc.
1800 W. Hawthorne Lane, Suite N
West Chicago, IL 60185
800-234-4900
www.norix.com



480a. Sand-ballasted seating

Ultra-Max Series

Norix Group, Inc.
1800 W. Hawthorne Lane, Suite N
West Chicago, IL 60185
800-234-4900
www.norix.com



480b. Sand-ballasted seating

Pineapple; Skye Plus ASKYP1-400

Pineapple Contracts
Westmead, Alyesford
Maidstone, Kent ME206XJ
+44(0)1622237830
www.pineapplecontracts.com

***PLEASE NOTE:***

Product information included in this document is intended for illustration of one or more specific items that are deemed appropriate for use in this type of facility. Comparable products by other manufacturers that meet the same design criteria may be substituted after careful comparison. No products are completely without risk. All product selections should be made in compliance with the findings of the comprehensive safety risk assessment for each location.

481a. Lightweight seating

Integra Series chairs

Norix Group, Inc.
1800 W. Hawthorne Lane, Suite N
West Chicago, IL 60185
800-234-4900
www.norix.com



481b. Lightweight seating

RazorBack Chair

Cortech® USA
7530 Plaza Court
Willowbrook, IL 60527
800-571-0770
www.cortechusa.com



481c. Lightweight seating

5000-20 Modumaxx stackable chair

Moduform
172 Industrial Road
Fitchburg, MA 01420
800-221-6638
www.moduform.com



481d. Lightweight seating

Pineapple; Boden Series seating

Pineapple Contracts, Inc.
1238 Anderson Court
Clawson, MI 48017
800-496-9324
www.pineapplecontracts.com



PLEASE NOTE:

Product information included in this document is intended for illustration of one or more specific items that are deemed appropriate for use in this type of facility. Comparable products by other manufacturers that meet the same design criteria may be substituted after careful comparison. No products are completely without risk. All product selections should be made in compliance with the findings of the comprehensive safety risk assessment for each location.

482a. Upholstered seating

Sierra Series chairs with solid end arms

Norix Group, Inc.
 1800 W. Hawthorne Lane, Suite N
 West Chicago, IL 60185
 800-234-4900
www.norix.com



482b. Upholstered seating

ML30/27BH Meridian Behavioral Health Seating – chair

Nemschoff
 909 North 8th Street
 Sheboygan, WI 53081
 800-203-8916
www.nemschoff.com



482c. Upholstered seating

Endurance Series

Blockhouse Company, Inc.
 3285 Farmtrail Road
 York, PA 17406
 800-346-1126
www.blockhouse.com



482d. Upholstered seating

Dignity Series

Spec Furniture Inc.
 65 City View Drive
 Toronto, Ontario M9W 5B1
 Canada
 888-761-7732
www.specfurniture.com

**PLEASE NOTE:**

Product information included in this document is intended for illustration of one or more specific items that are deemed appropriate for use in this type of facility. Comparable products by other manufacturers that meet the same design criteria may be substituted after careful comparison. No products are completely without risk. All product selections should be made in compliance with the findings of the comprehensive safety risk assessment for each location.

482e. Upholstered seating

Carrara

Kwalu
6160 Peachtree Dunwoody Rd., Building C
Atlanta, GA 30328
877-695-9258
www.kwalu.com



482f. Upholstered seating

Arcadia Series

Blockhouse Company, Inc.
3285 Farmtrail Road
York, PA 17406
800-346-1126
www.blockhouse.com



482g. Upholstered seating

Pineapple; Skye Plus ASKYP1-400

Pineapple Contracts, Inc.
1238 Anderson Court
Clawson, MI 48017
800-496-9324
www.pineapplecontracts.com

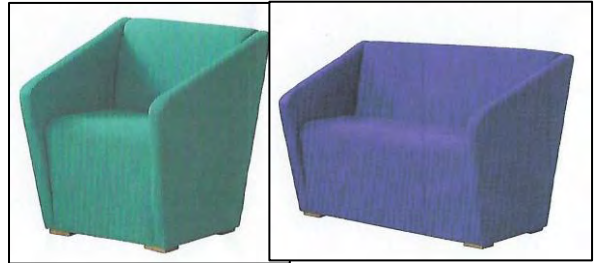

482h. Upholstered seating

Pineapple; Domus Lounge Seating

Pineapple Contracts, Inc.
1238 Anderson Court
Clawson, MI 48017
800-496-9324
www.pineapplecontracts.com



PLEASE NOTE:

Product information included in this document is intended for illustration of one or more specific items that are deemed appropriate for use in this type of facility. Comparable products by other manufacturers that meet the same design criteria may be substituted after careful comparison. No products are completely without risk. All product selections should be made in compliance with the findings of the comprehensive safety risk assessment for each location.

484c. PVC molded seating

Forté™ Lounge

Norix Group, Inc.
 1800 W. Hawthorne Lane, Suite N
 West Chicago, IL 60185
 800-234-4900
www.norix.com



484d. PVC molded seating

Hondo® Nuevo

Norix Group, Inc.
 1800 W. Hawthorne Lane, Suite N
 West Chicago, IL 60185
 800-234-4900
www.norix.com



484e. PVC molded seating

RockSmart

Norix Group, Inc.
 1800 W. Hawthorne Lane, Suite N
 West Chicago, IL 60185
 800-234-4900
www.norix.com

**12 56 70 - HEALTHCARE FURNITURE**

485a. Tables

Jupiter Series Tables

Norix Group, Inc.
 1800 W. Hawthorne Lane, Suite N
 West Chicago, IL 60185
 800-234-4900
www.norix.com

**PLEASE NOTE:**

Product information included in this document is intended for illustration of one or more specific items that are deemed appropriate for use in this type of facility. Comparable products by other manufacturers that meet the same design criteria may be substituted after careful comparison. No products are completely without risk. [All product selections should be made in compliance with the findings of the comprehensive safety risk assessment for each location.](#)

485b. Tables

Madera Series Tables

Norix Group, Inc.
1800 W. Hawthorne Lane, Suite N
West Chicago, IL 60185
800-234-4900
www.norix.com



490a. Electrically adjustable hospital bed

Behavioral Health Bed™

Sizewise
8601 Monrovia Street
Lenexa, KS 66215
800-814-9389
www.sizewise.com



490b. Electrically adjustable hospital bed

Spirit Bed with Mental Health Package

CHG Hospital Beds
1020 Adelaide Street S.
London, ON N6E 1R6
Canada
866-516-5446
www.chgbeds.com



490c. Electrically adjustable hospital bed

S3 MedSurg Bed

Stryker
2825 Airview Avenue
Kalamazoo, MI 49002
269-385-2600
www.stryker.com

**PLEASE NOTE:**

Product information included in this document is intended for illustration of one or more specific items that are deemed appropriate for use in this type of facility. Comparable products by other manufacturers that meet the same design criteria may be substituted after careful comparison. No products are completely without risk. All product selections should be made in compliance with the findings of the comprehensive safety risk assessment for each location.

492b. Behavioral health mattresses

Comfort Shield® Remedy Sealed Seam Mattress

Norix Group, Inc.
 1800 W. Hawthorne Lane, Suite N
 West Chicago, IL 60185
 800-234-4900
www.norix.com

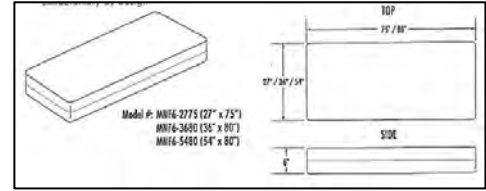

492c. Behavioral Health Mattresses

Sizewise Victory Series Mattresses

Sizewise
 1600 Genessee, Suite 950
 Kansas City, MO 64102
 800-814-9389
www.sizewise.net



492d. Behavioral health mattresses

Behavioral Health Mattress with Bed Bug Protection & BioArmour™ Infection Control Composite Lamination Surface

American Innovation Products
 12004 Trinity Road
 Trinity, NC 27370
 814-490-0660
www.americaninnovationproducts.com



492e. Behavioral health mattresses

Closed System™ Behavioral Health Mattress

Comfortex®
 1680 Wilkie Drive
 Winona, MN 55987
 800-445-4007
www.comfortexinc.com

**PLEASE NOTE:**

Product information included in this document is intended for illustration of one or more specific items that are deemed appropriate for use in this type of facility. Comparable products by other manufacturers that meet the same design criteria may be substituted after careful comparison. No products are completely without risk. All product selections should be made in compliance with the findings of the comprehensive safety risk assessment for each location.

493a. Platform bed

Roto Cast Series

Norix Group, Inc.
 1800 W. Hawthorne Lane, Suite N
 West Chicago, IL 60185
 800-234-4900
www.norix.com

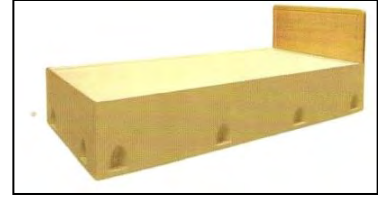

493d. Platform bed

BHBP/68 and BHHD/68 Behavioral Health Beds

Nemschoff
 909 North 8th Street
 Sheboygan, WI 53081
 800-203-8916
www.nemschoff.com/

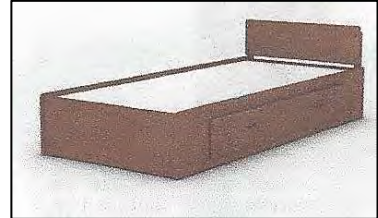

493e. Platform bed

Endurance Bed

Cortech® USA
 7530 Plaza Court
 Willowbrook, IL 60527
 800-571-0770
www.cortechusa.com



493f. Platform bed

Pineapple; Sovie Bed 1SVFA-100

Pineapple Contracts, Inc.
 1238 Anderson Court
 Clawson, MI 48017
 800-496-9324
www.pineapplecontracts.com



494a. Platform bed – lift-accessible

Sleigh Bed

Norix Group, Inc.
 1800 W. Hawthorne Lane, Suite N
 West Chicago, IL 60185
 800-234-4900
www.norix.com

**PLEASE NOTE:**

Product information included in this document is intended for illustration of one or more specific items that are deemed appropriate for use in this type of facility. Comparable products by other manufacturers that meet the same design criteria may be substituted after careful comparison. No products are completely without risk. All product selections should be made in compliance with the findings of the comprehensive safety risk assessment for each location.

494b. Platform bed riser – lift-accessible

Platform Bed Riser

Norix Group, Inc.
 1800 W. Hawthorne Lane, Suite N
 West Chicago, IL 60185
 800-234-4900
www.norix.com



495a. Patient room furniture

VISTA Series

Blockhouse Company, Inc.
 3285 Farmtrail Road
 York, PA 17406
 800-346-1126
www.blockhouse.com



495b. Patient room furniture

Safehouse Series

Norix Group, Inc.
 1800 W. Hawthorne Lane, Suite N
 West Chicago, IL 60185
 800-234-4900
www.norix.com



495c. Patient room furniture

Safe & Tough series

This End Up® Furniture Company, Inc.
 500 N. 7th Street
 Sanford, NC 27331
 800-605-2130
www.thisendup.com/groupliving.com

**PLEASE NOTE:**

Product information included in this document is intended for illustration of one or more specific items that are deemed appropriate for use in this type of facility. Comparable products by other manufacturers that meet the same design criteria may be substituted after careful comparison. No products are completely without risk. **All product selections should be made in compliance with the findings of the comprehensive safety risk assessment for each location.**

495d. Patient room furniture

Endurance Series

Cortech® USA
7530 Plaza Court
Willowbrook, IL 60527
800-571-0770
www.cortechusa.com



495e. Patient room furniture

Attenda Series

Norix Group, Inc.
1800 W. Hawthorne Lane, Suite N
West Chicago, IL 60185
800-234-4900
www.norix.com



496a. Patient room furniture

Attenda Series

Norix Group, Inc.
1800 W. Hawthorne Lane, Suite N
West Chicago, IL 60185
800-234-4900
www.norix.com



496b. Patient room furniture

Fortress Wardrobes

Moduform
172 Industrial Road
Fitchburg, MA 01420
800-221-6638
www.moduform.com



PLEASE NOTE:

Product information included in this document is intended for illustration of one or more specific items that are deemed appropriate for use in this type of facility. Comparable products by other manufacturers that meet the same design criteria may be substituted after careful comparison. No products are completely without risk. All product selections should be made in compliance with the findings of the comprehensive safety risk assessment for each location.

498. Seclusion room bed

450 Series Seclusion Beds (restraint loops optional)

Moduform
 172 Industrial Road
 Fitchburg, MA 01420
 800-221-6638
www.moduform.com



499a. Nurse servers

WALLAroo®

Carstens®, Inc.
 7310 West Wilson Avenue
 Chicago, IL 60706
 800-782-1524
www.carstens.com



499b. Nurse servers

Proximity EXT-28

Proximity Systems
 800-437-8111
www.proximiiitysystems.com

**12 93 43 - SITE FURNISHINGS - SEATING AND TABLES**

510. Outdoor Furniture

Hilltop Outdoor Furniture

Norix Group, Inc.
 1000 Atlantic Drive
 West Chicago, IL 60185
 1-800-234-4900
<http://www.norix.com>

**PLEASE NOTE:**

Product information included in this document is intended for illustration of one or more specific items that are deemed appropriate for use in this type of facility. Comparable products by other manufacturers that meet the same design criteria may be substituted after careful comparison. No products are completely without risk. All product selections should be made in compliance with the findings of the comprehensive safety risk assessment for each location.

21 00 00 - FIRE SUPPRESSION

21 13 13 - FIRE SUPPRESSION SPRINKLER SYSTEMS

520a. Fire sprinklers

Raven 5.6K Institutional Sprinklers

TYCO Fire Protection Products
1400 Pennbrook Parkway
Lansdale, PA 19446
800-523-6512
www.tyco-fire.com



520b. Fire sprinklers

819-S17 SR Sprinkler

Weizel Security
800-308-3627
www.securingshospitals.com

521a. Fire extinguisher cabinet

BestCare® Ligature-Resistant Recessed Fire Extinguisher Cabinet WH1704

Whitehall Manufacturing
P.O. Box 3527
City of Industry, CA 91744-0527
800-782-7706
www.whitehallmfg.com



22 43 00 - HEALTHCARE PLUMBING FIXTURES

22 43 13 - HEALTHCARE WATER CLOSETS

531. Toilet fixture, ADA– floor-mounted, back outlet

Huron EverClean Flushometer Toilet with integral seat

American Standard
1 Centennial Avenue
Piscataway, NJ 08855
800-488-8049
www.americanstandard-us.com



PLEASE NOTE:

Product information included in this document is intended for illustration of one or more specific items that are deemed appropriate for use in this type of facility. Comparable products by other manufacturers that meet the same design criteria may be substituted after careful comparison. No products are completely without risk. All product selections should be made in compliance with the findings of the comprehensive safety risk assessment for each location.

533. Solid-surface toilet fixture

CWC-156 AST-FF Behavioral HealthCare Toilet

Intersan Manufacturing Company
 1748 West Fillmore Street
 Phoenix, AZ 85007
 602-254-3101
www.intersan.us



534a. Stainless steel toilet

ETW-1490 Series

Willoughby Industries
 5105 West 78th Street
 Indianapolis, IN 46268
 800-428-4065
www.willoughby-ind.com



534b. Toilet fixture – stainless steel

BestCare® Ligature-Resistant Toilet, Top Supply, WH2142

Whitehall Manufacturing
 P.O. Box 3257
 City of Industry, CA 91744
 800-782-7706
www.whitehallmfg.com



536. Bariatric toilet fixtures

BET-1490 Series – Bariatric toilets

Willoughby Industries
 5105 West 78th Street
 Indianapolis, IN 46268
 800-428-4065
www.willoughby-ind.com



537. Toilet waste line clog removal assistant

Nallyator

Willoughby Industries
 5105 West 78th Street
 Indianapolis, IN 46268
 800-428-4065
www.willoughby-ind.com

**PLEASE NOTE:**

Product information included in this document is intended for illustration of one or more specific items that are deemed appropriate for use in this type of facility. Comparable products by other manufacturers that meet the same design criteria may be substituted after careful comparison. No products are completely without risk. All product selections should be made in compliance with the findings of the comprehensive safety risk assessment for each location.

22 43 16 - HEALTHCARE SINKS

540a. Wall-Hung Corner Lavatories

Ligature-Resistant, ADA Compliant Corterra Cast Solid Surface Corner Basin; WH3776 Series

Whitehall Manufacturing
P.O. Box 3527
City of Industry, CA 91744-0527
800-782-7706
www.whitehallmfg.com



540b. Wall-Hung Corner Lavatories

Ligature Resistant Solid Surface Wall-Hung Corner Lav.; CWC270

Intersan Manufacturing Company
1748 West Fillmore Street
Phoenix, AZ 85007
602-254-3101
www.intersan.us

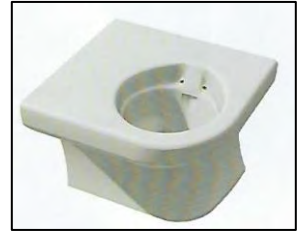

541a. Wall-Hung Lavatories

HSL1 SafeCare Ligature-Resistant Lavatory – stainless steel or high- impact polymer trap cover

Bradley Corporation
W142N9101 Fountain Boulevard
Menomonee Falls, WI 53051
800-272-3539
www.bradleycorp.com

**PLEASE NOTE:**

Product information included in this document is intended for illustration of one or more specific items that are deemed appropriate for use in this type of facility. Comparable products by other manufacturers that meet the same design criteria may be substituted after careful comparison. No products are completely without risk. All product selections should be made in compliance with the findings of the comprehensive safety risk assessment for each location.

541c. Wall-Hung Lavatories

Intersan - Saniwave lavatory with extensions

Intersan Manufacturing Company
 1748 West Fillmore Street
 Phoenix, AZ 85007
 602-254-3101
www.intersan.us



542a. Vanity top lavatory

Suicide Prevention Patient Sink Faucet

Norva Plastics, Inc
 3911 Killam Ave.
 Norfolk, VA 23508
 800-826-0758
www.norvaplastics.com



542b. Vanity top lavatory

Avonite® Acrylic Solid Surfaces

Avonite Surfaces
 7350 Empire Drive
 Florence, KY 41042
 800-354-9858
www.avonite.com

22 43 19 - HEALTHCARE BATHTUBS AND SHOWERS

550a. Shower head – ligature resistant

SP-7 Shower Head

Odd Ball Industries Mfg. Co., Inc.
 P.O. Box 376
 Greenlawn, NY 11740
 631-754-0400
www.oddballindustries.com

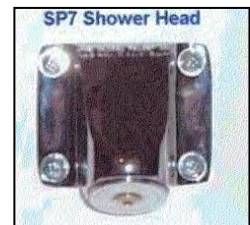
**PLEASE NOTE:**

Product information included in this document is intended for illustration of one or more specific items that are deemed appropriate for use in this type of facility. Comparable products by other manufacturers that meet the same design criteria may be substituted after careful comparison. No products are completely without risk. [All product selections should be made in compliance with the findings of the comprehensive safety risk assessment for each location.](#)

550c. Shower head – ligature resistant

Ligature-Resistant Shower Head – SH330

Behavioral Safety Products

29A N. Main St., Suite 3

Watkinsville, GA 30677

706-705-1500

www.besafepro.com



551. Shower head – ligature resistant w/quick disconnect and diverter valve

Dual Quick Connect – Wall Mounted Shower Head with Integral Diverter

Intersan Manufacturing Company

1748 West Fillmore Street

Phoenix, AZ 85007

602-254-3101

www.intersan.us

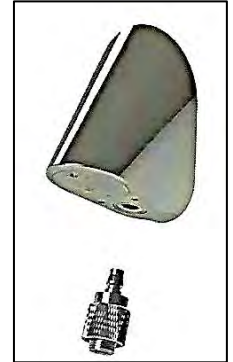

552a. Shower Control Valve

WH538-CSH Ligature-Resistant Shower Head and Valve

Whitehall Manufacturing

P.O. Box 3527

City of Industry, CA 91744-0527

800-782-7706

www.whitehallmfg.com



552b. Shower valve

Ligature-Resistant Shower Valve – SV230

Behavioral Safety Products

29A N. Main St., Suite 3

Watkinsville, GA 30677

706-705-1500

www.besafepro.com



PLEASE NOTE:

Product information included in this document is intended for illustration of one or more specific items that are deemed appropriate for use in this type of facility. Comparable products by other manufacturers that meet the same design criteria may be substituted after careful comparison. No products are completely without risk. All product selections should be made in compliance with the findings of the comprehensive safety risk assessment for each location.

552c. Shower valve

834-S40 SR™ Retrofit Shower Knob

Weizel Security

800-308-3627

www.securingshospitals.com



552d. Shower valve

SP-10 Shower Mixing Valve

Odd Ball Industries

P.O. Box 376

Greenlawn, NY 11740

1-631-754-0400

www.oddballindustries.com



552e. Shower valve

Sense™ DMV2 – Individual Shower concealed electronic mixing valve with optional stainless steel cover

Armstrong International

816 Maple Street

Three Rivers, MI 49093

269-273-1415

www.armstronginternational.com



555a. Shower diverter valve

834-SN2 SR™ Diverter Valve Assembly

Weizel Security

800-308-3627

www.securingshospitals.com



555b. Shower diverter valve

SP-12 Diverter Valve for shower

Odd Ball Industries

P.O. Box 376

Greenlawn, NY 11740

631-754-0400

www.oddballindustries.com



PLEASE NOTE:

Product information included in this document is intended for illustration of one or more specific items that are deemed appropriate for use in this type of facility. Comparable products by other manufacturers that meet the same design criteria may be substituted after careful comparison. No products are completely without risk. All product selections should be made in compliance with the findings of the comprehensive safety risk assessment for each location.

560a. Shower assembly

**BestCare® Flush-Mount Ligature-Resistant Security Shower
WH1741-CSH**

Whitehall Manufacturing
P.O. Box 3527
City of Industry, CA 91744-0527
800-782-7706
www.whitehallmfg.com

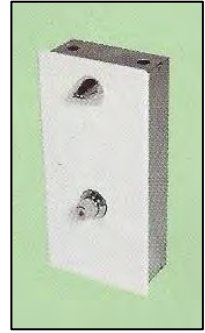

560b. Shower assembly

SR834-S35 SR™ Shower Panel

Weizel Security
800-308-3627
www.securingshospitals.com

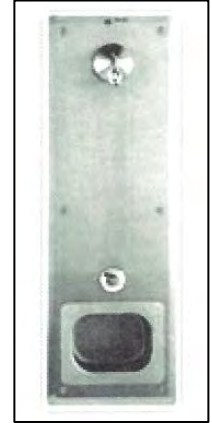

562. Shower assembly – recessed hand-held

M0418-E508 in locking box

Acorn Engineering
15125 Proctor Avenue
City of Industry, CA 91746
800-488-8999
www.acorneng.com

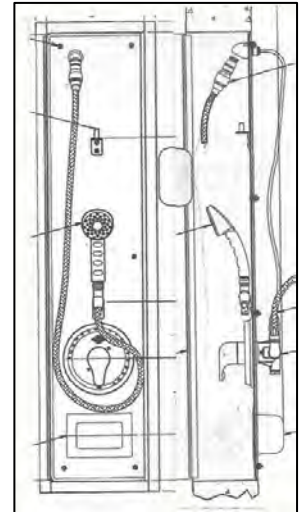
**PLEASE NOTE:**

Product information included in this document is intended for illustration of one or more specific items that are deemed appropriate for use in this type of facility. Comparable products by other manufacturers that meet the same design criteria may be substituted after careful comparison. No products are completely without risk. All product selections should be made in compliance with the findings of the comprehensive safety risk assessment for each location.

563a. Shower assembly – handicapped accessible

Quick release hand held shower head; Model 40707

Intersan Manufacturing Company
1748 West Fillmore Street
Phoenix, AZ 85007
800-999-3101
www.intersanus.com



563b. Shower assembly – handicapped accessible

SP-7WC Shower Head with Quick Connect Hand Shower

Odd Ball Industries
P.O. Box 376
Greenlawn, NY 11740
1-631-754-0400
www.oddballindustries.com



563c. Shower assembly – handicapped accessible

BestCare® Flush-Mount Ligature-Resistant Security Shower with Dual Heads WH1741-FH-CSH

Whitehall Manufacturing
P.O. Box 3527
City of Industry, CA 91744-0527
800-782-7706
www.whitehallmfg.com

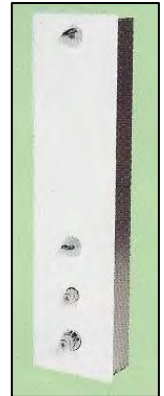

PLEASE NOTE:

Product information included in this document is intended for illustration of one or more specific items that are deemed appropriate for use in this type of facility. Comparable products by other manufacturers that meet the same design criteria may be substituted after careful comparison. No products are completely without risk. All product selections should be made in compliance with the findings of the comprehensive safety risk assessment for each location.

22 43 23 - HEALTHCARE SHOWER RECEPTORS AND BASINS

564a. Shower linear drain

ProLine drain with “dots” cover

QuickDrain USA
101 W. Main Street #206
Frisco, CO 80443
866-998-6685
www.quickdrainusa.com

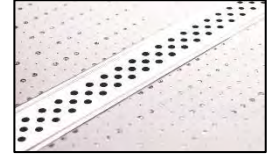

564b. Shower floor basin

Roll-in shower with front trench

Watermark
2969 armory Drive, Suite 400
Nashville, TN 37204
615-291-6111
www.watermarksolidsurface.com/product-category/all-shower-systems/5

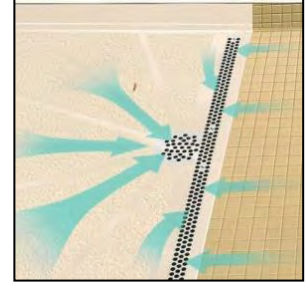

564c. Shower floor basin

AquaSurf solid surface shower bases

Willoughby Industries
5105 West 78th Street
Indianapolis, IN 46268
800-428-4065
www.willoughby-ind.com

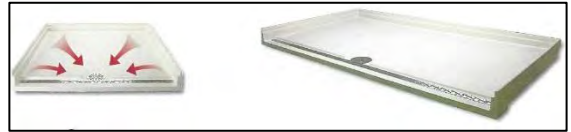

565a. Ligature Resistant Drain Cover

Crocodile Roll Resistant Floor Drain; 303070X

Intersan Manufacturing Company
1748 West Fillmore Street
Phoenix, AZ 85007
800-999-3101
www.intersanus.com



PLEASE NOTE:

Product information included in this document is intended for illustration of one or more specific items that are deemed appropriate for use in this type of facility. Comparable products by other manufacturers that meet the same design criteria may be substituted after careful comparison. No products are completely without risk. All product selections should be made in compliance with the findings of the comprehensive safety risk assessment for each location.

565b. Ligature Resistant Drain Cover

Tower Industries ; Anti-Ligature Drain Cover – Model SDC-AL-1-S

Tower Industries
 2101 Ninth Street SW
 Massillon, OH 44647
 330-837-2216
www.towershowers.com



565c. Ligature Resistant Drain Cover

BestCare® Ligature-Resistant Floor Drain Grate WHDG Series

Whitehall Manufacturing
 15125 Proctor Avenue
 City of Industry, CA 91746
 800-782-7706
www.whitehallmfg.com



565d. Ligature Resistant Drain Cover

BestCare® Ligature-Resistant Linear Drain with Flashing Flange WHLD Series

Whitehall Manufacturing
 15125 Proctor Avenue
 City of Industry, CA 91746
 800-782-7706
www.whitehallmfg.com

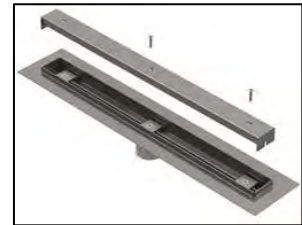

566. One-piece patient toilet room floor

UniFloor

Bestbath®
 723 Garber Street
 Caldwell, ID 83605
 800-727-9907
www.bestbath.com

***PLEASE NOTE:***

Product information included in this document is intended for illustration of one or more specific items that are deemed appropriate for use in this type of facility. Comparable products by other manufacturers that meet the same design criteria may be substituted after careful comparison. No products are completely without risk. All product selections should be made in compliance with the findings of the comprehensive safety risk assessment for each location.

567. Shower floor basin

The Swan Corporation, Swanstone Solid Surface Shower Floors

The Swan Corporation

One City Centre, Suite 2300

St. Louis, MO. 63101

1-314-231-8148

<http://www.theswancorp.com>

568a. Pre-built bathrooms

Pre-Built Bathrooms

Eggrock, LLC

265 Foster Street

Littleton, MA 01460

978-952-8800

www.eggrock.com

568b. Pre-built bathrooms

SurePods™

Oldcastle®

2300 Principal Row

Orlando, FL 32837

407-859-7034

<https://oldcastlesurepods.com>**22 43 39 - HEALTHCARE FAUCETS**

570a. Lavatory faucet

Ligature-Resistant Metering Faucet – SF380

Behavioral Safety Products

29A N. Main St., Suite 3

Watkinsville, GA 30677

706-705-1500

www.besafepro.com**PLEASE NOTE:**

Product information included in this document is intended for illustration of one or more specific items that are deemed appropriate for use in this type of facility. Comparable products by other manufacturers that meet the same design criteria may be substituted after careful comparison. No products are completely without risk. All product selections should be made in compliance with the findings of the comprehensive safety risk assessment for each location.

570b. Lavatory faucet

Suicide Prevention Patient Sink Faucet

Norva Plastics, Inc
3911 Killam Ave.
Norfolk, VA 23508
800-826-0758
www.norvaplastics.com



570c. Lavatory faucet

BestCare® Ligature-resistant, ADA-compliant faucet 3377 w/2 two pneumatic buttons

Whitehall Manufacturing
P.O. Box 3527
City of Industry, CA 91744-0527
800-782-7706
www.whitehallmfg.com



574. Lavatory with countertop valve

Lavatory Valve

Odd Ball Industries
P.O. Box 376
Greenlawn, NY 11740
631-754-0400
www.oddballindustries.com



22 43 43 - HEALTHCARE PLUMBING FIXTURE FLUSHOMETERS

580. Recessed flush valve

Royal 611 & WB-1-A Easy Access Wall Box

Sloan®
10500 Seymour Avenue
Franklin Park, IL 60131
800-982-5839
www.sloan.com



PLEASE NOTE:

Product information included in this document is intended for illustration of one or more specific items that are deemed appropriate for use in this type of facility. Comparable products by other manufacturers that meet the same design criteria may be substituted after careful comparison. No products are completely without risk. All product selections should be made in compliance with the findings of the comprehensive safety risk assessment for each location.

581a. Recessed flush valve

Regal 955 Hydraulic Concealed Flushometer & WB-1-A Easy Access Wall Box

Sloan®
 10500 Seymour Avenue
 Franklin Park, IL 60131
 800-982-5839
www.sloan.com



581b. Recessed flush valve

3-inch Push Button Assembly for Concealed Flush Valves – P6000-NL3

Zurn Industries
 511 W. Freshwater Way
 Milwaukee, WI 53204
 855-663-9876
www.zurn.com

585a. Flush valve cover

HSC79 SafeCare Ligature-Resistant Flush Valve Cover

Bradley Corporation
 W142N9101 Fountain Boulevard Menomonee Falls, WI
 53051
 800-272-3539
www.bradleycorp.com

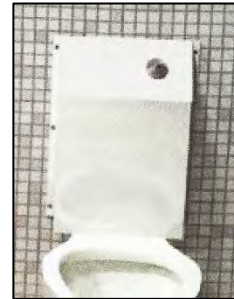

585b. Flush valve cover

FV500 (2 piece) & FV600 (1 piece) Ligature Resistant Flush Valve Cover

Behavioral Safety Products
 29A N. Main St., Suite 3
 Watkinsville, GA 30677
 706-705-1500
www.besafepro.com

**PLEASE NOTE:**

Product information included in this document is intended for illustration of one or more specific items that are deemed appropriate for use in this type of facility. Comparable products by other manufacturers that meet the same design criteria may be substituted after careful comparison. No products are completely without risk. All product selections should be made in compliance with the findings of the comprehensive safety risk assessment for each location.

585c. Flush valve cover

831-S39 SR™ Flush Valve Cover

Weizel Security
Unit 9 – 62 Fawcett Road
Coquitlam, BC, Canada V3K 6V5
800-308-3627
www.securingshospitals.com



585d. Flush valve cover

Ligature-Resistant Box with Flush Valve WH2802 – for various toilet or urinal

Whitehall Manufacturing
P.O. Box 3527
City of Industry, CA 91744-0527
800-782-7706
www.whitehallmfg.com



588. Recessed bedpan washer

Recessed Bedpan Washer

Willoughby Industries
5105 West 78th Street
Indianapolis, IN 46268
800-428-4065
www.willoughby-ind.com

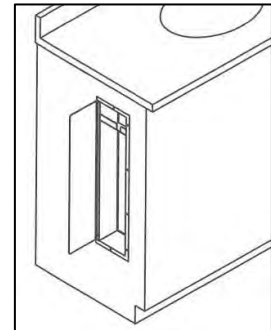
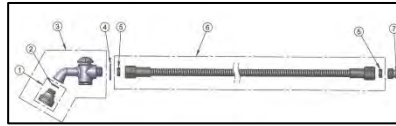

22 47 00 – WATER STATION WATER COOLERS

589a. Drinking water cup filling stations

B103-C2-HR Water Bottle Filling Station Cup Dispenser and Disposal with security features

Filtrine Manufacturing Company
15 Kit Street,
Keene, NH 03431
800-930-3367
www.filtrine.com



PLEASE NOTE:

Product information included in this document is intended for illustration of one or more specific items that are deemed appropriate for use in this type of facility. Comparable products by other manufacturers that meet the same design criteria may be substituted after careful comparison. No products are completely without risk. All product selections should be made in compliance with the findings of the comprehensive safety risk assessment for each location.

589b. Drinking water cup filling stations

Quench 755 Countertop Filtered Water Cooler with UV

Quench
 780 5th Avenue, Suite 200
 King of Prussia, PA 19406
 888-877-0561
www.quenchonline.com

**22 60 00 – GAS AND VACUUM SYSTEMS FOR HEALTHCARE FACILITIES**

590a. Medical gas covers

Security Patient Console

Hospital Systems, Inc.
 750 Garcia Avenue
 Pittsburg, CA 94565
 925-427-7800
www.hsiheadwalls.com



590b. Medical gas covers

Recessed Security Console

Modular Services Company
 500 East Britton Road
 Oklahoma City, OK 73114
 800-687-0938
www.modularservices.com/products-services/products-type/secure



590c. Medical gas covers

Security Headwalls w/ 3/8" polycarbonate locked cover bottom hinge

Modular Services Company
 500 East Britton Road
 Oklahoma City, OK 73114
 800-687-0938
www.modularservices.com
www.filtrine.com

**PLEASE NOTE:**

Product information included in this document is intended for illustration of one or more specific items that are deemed appropriate for use in this type of facility. Comparable products by other manufacturers that meet the same design criteria may be substituted after careful comparison. No products are completely without risk. All product selections should be made in compliance with the findings of the comprehensive safety risk assessment for each location.

23 00 00 - HEATING, VENTILATING AND AIR CONDITIONING

23 37 13 - DIFFUSERS, REGISTERS AND GRILLES

600a. Air grilles - "S" vane

RSPA41 Security Grille – "S" vane

Carnes® Company
448 South Main Street
Verona, WI 53593
608-845-6411
www.carnes.com

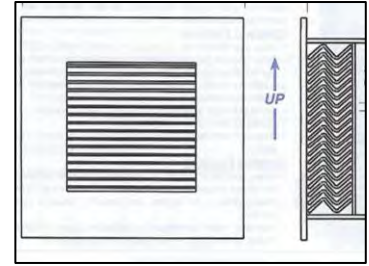

600b. Air grilles - "S" vane

SEG-9 Security Grille – supply or return

Kees Incorporated
400 S. Industrial Drive, PO Box 327
Elkhart Lake, WI 53020-0327
920-876-3391
www.kees.com

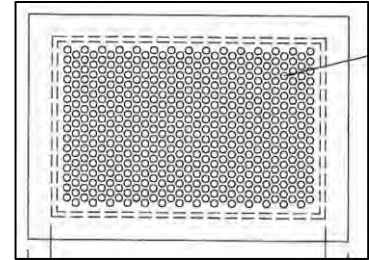

600c. Air grille - "S" vane

814-R17 SR™ V-Vent High Security Grille

Weizel Security
800-308-3627
www.securingshospitals.com

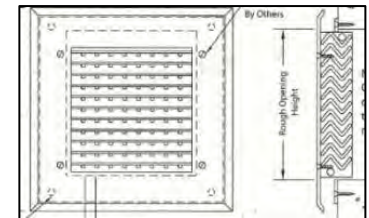

600d. Air grilles - "S" vane

SSV432Maximum Security Ceiling Diffuser

Anemostat® Air Distribution
1220 Watson Center Road
Carson, CA. 90745
310-835-7500
www.anemostat.com

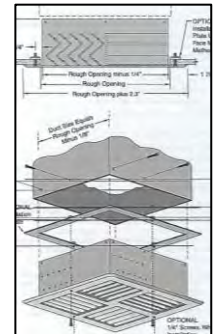

PLEASE NOTE:

Product information included in this document is intended for illustration of one or more specific items that are deemed appropriate for use in this type of facility. Comparable products by other manufacturers that meet the same design criteria may be substituted after careful comparison. No products are completely without risk. All product selections should be made in compliance with the findings of the comprehensive safety risk assessment for each location.

602a. Air grille – max security

RRMX Extra Heavy Duty Grille with Removable Steel Perforated Face Plate

Anemostat® Air Distribution
1220 Watson Center Road
Carson, CA. 90745
310-835-7500
www.anemostat.com

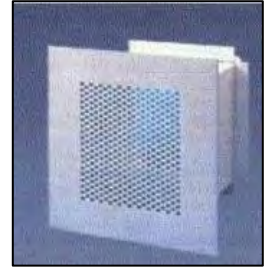

602b. Air grille – max security

SG-SD Maximum Security Suicide Deterrent Grille, steel with 3/16-inch holes

Titus
605 Shiloh Road
Plano, TX 75074
972-212-4800
www.titus-hvac.com

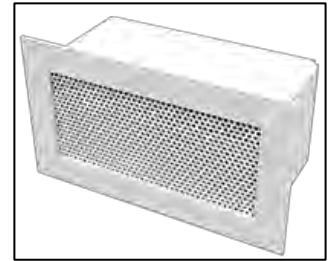

602c. Air grilles - Perforated

RSPA51 Security Grille - Perforated

Carnes® Company
448 South Main Street
Verona, WI 53593
608-845-6411
www.carnes.com



606. Fan coil enclosures

Fan Coil Covers - Security

ARSCO Manufacturing Company
5313 Robert Avenue
Cincinnati, OH 45248
800-543-7040
www.arscomfg.com



PLEASE NOTE:

Product information included in this document is intended for illustration of one or more specific items that are deemed appropriate for use in this type of facility. Comparable products by other manufacturers that meet the same design criteria may be substituted after careful comparison. No products are completely without risk. All product selections should be made in compliance with the findings of the comprehensive safety risk assessment for each location.

607. Thermostat – tamper-resistant

KTP Series Stainless Steel Flush-Mount Thermistor

Kele, Inc.
3300 Brother Blvd.
Bartlett, TN 38133
877-826-9045
www.kele.com

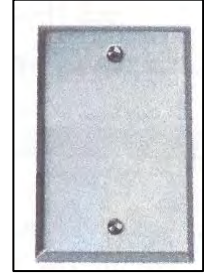

26 00 00 - ELECTRICAL

26 27 26 – ELECTRICAL DEVICES

610a. Hospital-grade receptacles

Hospital Grade GFCI Receptacles

Hubbell Incorporated
Wiring Device-Kellems
40 Waterview Drive
Shelton, CT 06484
800-288-6000
www.hubbell-wiring.com



610b. Hospital-grade receptacles

Hospital Grade GFCI Receptacles

Cooper Industries
PO Box 4446
Houston, TX 77210-4446
713-209-8400
www.cooperindustries.com

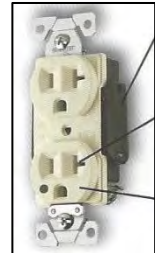

611a. Key-operated electric switches

Pass & Seymour Locking Keyed Switch

Legrand North America, LLC
<http://www.legrand.us/passandseymour.aspx>



PLEASE NOTE:

Product information included in this document is intended for illustration of one or more specific items that are deemed appropriate for use in this type of facility. Comparable products by other manufacturers that meet the same design criteria may be substituted after careful comparison. No products are completely without risk. All product selections should be made in compliance with the findings of the comprehensive safety risk assessment for each location.

611b. Key-operated electric switches

Leviton 1221-2KL Key Locking Extra Heavy Duty Switch

Leviton Manufacturing Co., Inc.

www.leviton.com



612c. Polycarbonate electrical coverplates

Tiger Plates

Cortech® USA

7530 Plaza Court

Willowbrook, IL 60527

800-571-0700

www.cortechusa.com

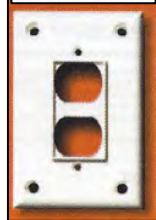

26 51 00 – INTERIOR LIGHTING

620a. Light fixture

NASL-RND LED 2' diameter w/ flat polycarbonate lens and tamper resistant screws

Day-O-Lite

126 Chestnut Street

Warwick, RI 02888

401-467-8232

www.dayolite.com

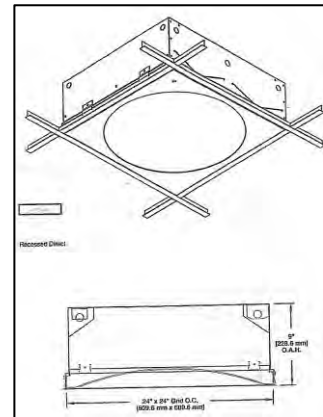

620b. Light fixture

Fino® ceiling mount and wall mount light fixtures

Amerlux®, LLC

178 Bauer Drive

Oakland, NJ 07436

973-882-5010

www.amerlux.com

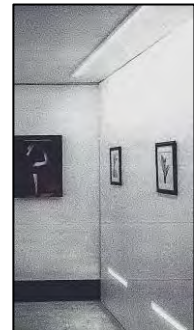

PLEASE NOTE:

Product information included in this document is intended for illustration of one or more specific items that are deemed appropriate for use in this type of facility. Comparable products by other manufacturers that meet the same design criteria may be substituted after careful comparison. No products are completely without risk. All product selections should be made in compliance with the findings of the comprehensive safety risk assessment for each location.

620c. Light fixture

Mighty Mac TW Series TUNABLE Color SSA Slope Sided Surface Mount or RMCD Recessed Mount vandal resistant light fixtures

Kenall®
10200 55th Street
Kenosha, WI 53144
800-453-6255
www.kenall.com

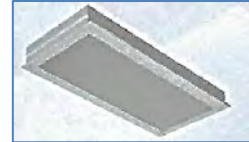

620d. Light fixture

Fail-Safe SGI recessed, sealed, and gasketed with polycarbonate lens

Eaton's Cooper Lighting
1121 Highway 74 South
Peachtree City, GA 30269
770-486-4800
www.cooperindustries.com



620e. Light fixture

818-R13 SR™ Recessed Ceiling Lighting with polycarbonate lens

Weizel Security
800-308-3627
www.securingshospitals.com



RECESSED DESIGN REDUCES LIGATURE RISK



SLOPED DESIGN REDUCES LIGATURE RISK

620f. Light fixture

Mighty Mac WCBU Two-Aperture Bull Nose series

Kenall®
10200 55th Street
Kenosha, WI 53144
800-453-6255
www.kenall.com

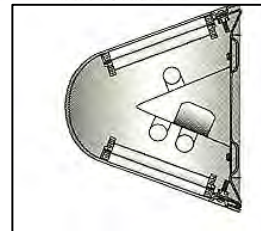

PLEASE NOTE:

Product information included in this document is intended for illustration of one or more specific items that are deemed appropriate for use in this type of facility. Comparable products by other manufacturers that meet the same design criteria may be substituted after careful comparison. No products are completely without risk. All product selections should be made in compliance with the findings of the comprehensive safety risk assessment for each location.

620g. Light fixture

RDL/RHL Wet Label Downlight

Designplan
79 Trenton Avenue
Frenchtown, NJ 08825
908-996-7710
www.designplan.com



620h. Light fixture

Sonar 12 SPC12 Vandal Resistant wall mount fixture

Luminaire Lighting Corporation
5 Sutton Place
P. O. Box 2162
Edison, NJ 08818
732-549-0056
www.luminairelighting.com



620i. Light fixture

Anyx-13 ARV-13 Vandal Resistant round wall/ceiling mount fixture

Luminaire Lighting Corporation
5 Sutton Place
P. O. Box 2162
Edison, NJ 08818
732-549-0056
www.luminairelighting.com

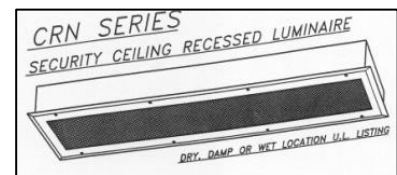

PLEASE NOTE:

Product information included in this document is intended for illustration of one or more specific items that are deemed appropriate for use in this type of facility. Comparable products by other manufacturers that meet the same design criteria may be substituted after careful comparison. No products are completely without risk. All product selections should be made in compliance with the findings of the comprehensive safety risk assessment for each location.

620j. Light fixture

CRN Series with clear polycarbonate external lens and TP door fasteners

The L.C. Doane Company
 P.O. Box 700
 Ivoryton, CT. 06442
 860-767-8295
www.lcdoane.com

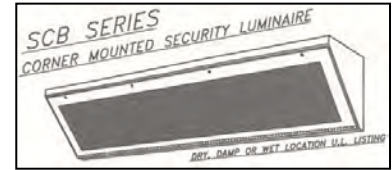

624. Polycarbonate prismatic lens

CRN Series with prismatic polycarbonate lens

The L.C. Doane Company
 P.O. Box 700
 Ivoryton, CT. 06442
 860-767-8295
www.lcdoane.com

624. Individual reading light

Visa Lighting; Gig with BH1 mounting bracket & polycarbonate lens

Visa Lighting
 1717 W. Civic Drive
 Milwaukee, WI 53209
 800-788-8472
www.visalighting.com

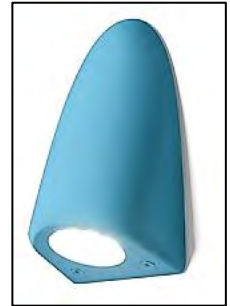

630. Downlight cover

Recesso Lights

Recesso Lighting by Dolan Designs
 13501 100th Avenue NE, #524
 Kirkland, WA 98034
 877-357-6127
<http://recessolighting.com>

**PLEASE NOTE:**

Product information included in this document is intended for illustration of one or more specific items that are deemed appropriate for use in this type of facility. Comparable products by other manufacturers that meet the same design criteria may be substituted after careful comparison. No products are completely without risk. All product selections should be made in compliance with the findings of the comprehensive safety risk assessment for each location.

637. Exterior lighting

Exterior Vandal Resistant Lighting

The Kirlin Company
 3401 East Jefferson Avenue
 Detroit, MI 48207
 313-259-6400
www.kirlinlighting.com

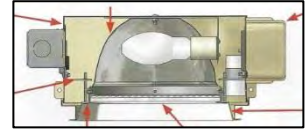

639. Night-light

CM-25500 PathMaster Die Cast Mini LED Step Light

Philips Lighting North America Corporation
 (Chloride)
 200 Franklin Square Drive
 Somerset, NJ 08873
 855-486-2216
www.lightingproducts.philips.com

**26 53 00 – EXIT SIGNS**

640a. Exit signs, LED – vandal-resistant

Commercial Exist Signs SC Series – Cast Aluminum LED with vandal-resistant lens and tamperproof hardware

Philips Lighting North America Corporation (Chloride)
 200 Franklin Square Drive
 Somerset, NJ 08873
 855-486-2216
www.lightingproducts.philips.com



640b. Exit signs, lighted – vandal-resistant

Mighty Mac MMEX Surface, Wall, or Ceiling Mount Single/Double Face Exit w/ full-length mounting canopy

Kenall®
 10200 55th Street
 Kenosha, WI 53144
 800-453-6255
www.kenall.com

**PLEASE NOTE:**

Product information included in this document is intended for illustration of one or more specific items that are deemed appropriate for use in this type of facility. Comparable products by other manufacturers that meet the same design criteria may be substituted after careful comparison. No products are completely without risk. All product selections should be made in compliance with the findings of the comprehensive safety risk assessment for each location.

642. Exit signs - photoluminescent

EX424246-100G Ecoglo® Photoluminescent Exit Sign

Access Products Inc.
241 Main Street, Suite 100
Buffalo, NY 14203
888-679-4022
www.us.ecoglo.com

26 55 53 – SECURITY LIGHTING

643. Covers

Norva Plastics – Life/Fire Safety Lexan Covers

Norva Plastics, Inc
3911 Killam Ave.
Norfolk, VA 23508
800-826-0758
www.norvaplastics.com



27 00 00 - COMMUNICATIONS

27 32 13 - TELEPHONE SETS

645a. Stainless steel wall phones

GB306V-14 Vandal-Resistant Telephone with 14" armored cord

Allen Tel Products, Inc.
30 TVS Drive
Henderson, NV 89014
702-855-5700
www.allentel.com



645b. Stainless steel wall phones

SSW-321-X Ceeco Stainless Steel Wall Phone

TWAcomm.com
8700 Warner Avenue, Suite 120
Fountain Valley, CA 92708
877-389-0000
www.twacomm.com



PLEASE NOTE:

Product information included in this document is intended for illustration of one or more specific items that are deemed appropriate for use in this type of facility. Comparable products by other manufacturers that meet the same design criteria may be substituted after careful comparison. No products are completely without risk. [All product selections should be made in compliance with the findings of the comprehensive safety risk assessment for each location.](#)

645c. Stainless steel wall phones

JP3500 Armored Courtesy Phone

G-Tel Enterprises, Inc.
 16840 Clay Road, #118
 Houston, TX 77084
 800-884-4835
www.payphone.com

**27 52 23 – NURSE CALL/CODE BLUE SYSTEMS**

650a. Wireless duress alarm

INSTANTalarm® 5000

Pinpoint®, Inc.
 2100 Southbridge Parkway, Suite 650
 Birmingham, AL 35209
 205-414-7541
www.pinpointinc.com

650f. Wireless duress alarm

B3000n Communication Badge

Vocera®
 525 Race Street
 San Jose, CA 95126
 888-986-2372
www.vocera.com



653. Nurse call system – vandal-resistant

HSS401 Responder Health Care Communications System High Security Staff Duty Station

Rauland-Borg Corporation
 1802 West Central Road
 Mount Prospect, IL 60056
 800-752-7725
www.rauland.com

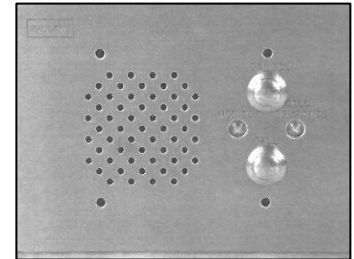
**PLEASE NOTE:**

Product information included in this document is intended for illustration of one or more specific items that are deemed appropriate for use in this type of facility. Comparable products by other manufacturers that meet the same design criteria may be substituted after careful comparison. No products are completely without risk. All product selections should be made in compliance with the findings of the comprehensive safety risk assessment for each location.

654. Pushbutton switch – vandal-resistant

PV1-PV8 Anti-Vandal Switches

Lamb Industries
7153 Northland Drive
Minneapolis, MN 55428
800-867-2717

<http://www.e-switch.com/>



28 00 00 – ELECTRONIC SAFETY AND SECURITY

28 40 00 – ELECTRONIC MONITORING AND CONTROL

660. Metal Detectors

Metrasens; Proscreen 200

Metrasens
2150 Western Court, Suite 360
Lisle, IL 60532
630-541-6509

<http://www.metrasens.com/>



32 00 00 – EXTERIOR IMPROVEMENTS

32 31 13 - SECURITY FENCING

675a. Security fencing

Mini-Mesh chain-link fencing

Fence Factory
29149 Agoura Road
Agoura Hills, CA 91301
800-613-3623

www.fencefactory.com

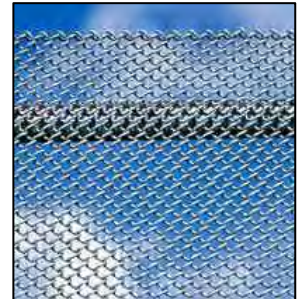

675b. Security fencing

WireWall® High Security Fencing - Maximum Security

Riverdale Mills Corporation
130 Riverdale Street; PO Box 920
Northbridge, MA 01534
800-762-6374

www.riverdale.com



PLEASE NOTE:

Product information included in this document is intended for illustration of one or more specific items that are deemed appropriate for use in this type of facility. Comparable products by other manufacturers that meet the same design criteria may be substituted after careful comparison. No products are completely without risk. All product selections should be made in compliance with the findings of the comprehensive safety risk assessment for each location.

675c. Security fencing

Steel fence systems

METALCO Fence & Railing Systems, Inc.

3050 Sirius Ave, Suite 104

Las Vegas, NV 89102

800-708-2526

fence-system.com

675d. Security fencing

Fortress Fencing

Britplas

18 Kingsland Grange

Woolston

Warrington, Cheshire, England WA1 4RW

+44(01)-1925-824317

www.britplas.com**PLEASE NOTE:**

Product information included in this document is intended for illustration of one or more specific items that are deemed appropriate for use in this type of facility. Comparable products by other manufacturers that meet the same design criteria may be substituted after careful comparison. No products are completely without risk. [All product selections should be made in compliance with the findings of the comprehensive safety risk assessment for each location.](#)

ABOUT THE AUTHORS

James M. Hunt, AIA, is a practicing architect and facility management professional with more than 40 years of experience. He is a registered architect and began his career practicing architecture for several major health care projects. He then served as director of facility management for the Menninger Clinic for 20 years. In addition to managing the clinic's main campus, he consulted on behavioral health care unit remodeling projects for their Clinical Network program in eight states. During this time, Mr. Hunt was a founding member of the Health Care Council of the International Facility Management Association. He held several offices in the council, including chair. He publishes articles and speaks at major conferences frequently. He is president of Behavioral Health Facility Consulting, LLC (BHFC), an organization that consults with behavioral health organizations and architects who design behavioral health facilities regarding their unique requirements for patient and staff safety. He has worked with behavioral health facilities in more than 30 states and Canada. He can be reached at jim@bhfc.com.

David M. Sine, DrBE, CSP, ARM, CPHRM, has had a career of more than 25 years in safety, risk management, human factors, and organizational consulting. He has been state safety director of two eastern states, senior staff engineer for the Joint Commission, and a senior consultant for the American Hospital Association. Founding partner and one-time contributing editor for *Briefings on Hospital Safety*, co-author of *Quality Improvement Techniques for Hospital Safety*, and one-time vice chair of the board of Brackenridge Hospital in Austin, Texas, Mr. Sine is certified by the Joint Board of the American Board of Industrial Hygiene and Certified Safety Professionals and as a Certified Professional Healthcare Risk Manager by ASHRM. He has been a health care risk management consultant since 1980 and has conducted more than 1,300 Joint Commission compliance assessment surveys. He serves as a member of the NFPA 101 Life Safety Code Subcommittee on Health Care Occupancies, the Joint Commission Committee on Healthcare Safety, and the FGI Health Guidelines Revision Committee and acts as a risk management adviser to the National Association of Psychiatric Health Systems. He served in the corporate offices of the Tenet HealthSystem in Dallas as director of risk assessment and loss prevention and vice president of occupational health and safety. Mr. Sine continues to write and lecture extensively on health care policy, governance, quality improvement, and risk management as President of SafetyLogic Systems. He can be reached at dsine9@gmail.com.

PLEASE NOTE:

Product information included in this document is intended for illustration of one or more specific items that are deemed appropriate for use in this type of facility. Comparable products by other manufacturers that meet the same design criteria may be substituted after careful comparison. No products are completely without risk. [All product selections should be made in compliance with the findings of the comprehensive safety risk assessment for each location.](#)

DEFINITIONS / RESOURCES

Americans with Disabilities Act (ADA). The *Americans with Disabilities Act* gives civil rights protections to individuals with disabilities similar to those provided to individuals on the basis of race, color, sex, national origin, age, and religion. It guarantees equal opportunity for individuals with disabilities in public accommodations, employment, transportation, state and local government services, and telecommunications. See www.ada.gov/.

Guidelines for Design and Construction of Hospitals and Outpatient Facilities – 2014 edition. This book, published by the Facility Guidelines Institute, includes chapters on psychiatric hospitals and outpatient psychiatric centers. For information on purchasing the FGI *Guidelines*, visit www.fgiguideines.org.

Health Insurance Portability and Accountability Act of 1996 (HIPAA). The Office for Civil Rights in the U.S. Department of Health and Human Services (HHS) enforces the HIPAA Privacy Rule, which protects the privacy of individually identifiable health information; the HIPAA Security Rule, which sets national standards for the security of electronic protected health information; and the confidentiality provisions of the Patient Safety Rule, which protect identifiable information being used to analyze patient safety events and improve patient safety. See www.hhs.gov/ocr/privacy.

The Joint Commission. See www.jointcommission.org for their standards.

National Fire Protection Association (NFPA). The NFPA publishes NFPA 101: *Life Safety Code*®, which is available at http://www.nfpa.org/catalog/product.asp?pid=10109&order_src=A291. For more on NFPA or links to new publications, see www.NFPA.org.

National Institute of Corrections. See www.nicic.gov.

PLEASE NOTE:

Product information included in this document is intended for illustration of one or more specific items that are deemed appropriate for use in this type of facility. Comparable products by other manufacturers that meet the same design criteria may be substituted after careful comparison. No products are completely without risk. [All product selections should be made in compliance with the findings of the comprehensive safety risk assessment for each location.](#)

LIST OF MANUFACTURERS

Access Products, www.us.ecoglo.com
Accurate, www accuratelockandhardware.com
Ace Security, www.smashandgrab.com
Acorn Engineering Co., www.acorneng.com
Allen Tel Products, www.allentel.com
Alro Plastics, www.alro.com
American Innovation, www.americaninnovationproducts.com
American Specialties, www.americanspecialties.com
American Standard, www.americanstandard-us.com/
Anemostat, www.anemostat-hvac.com
Archer Manufacturing, www.vandalproof.org
Armstrong Flooring, www.armstrong.com
Armstrong International, <http://armstronginternational.com>
Arso, www.arscomfg.com
Avonite, www.avonitesurfaces.com
BASF, www.master-builders-solutions.basf.us
Behavioral Safety Products, www.besafepro.com
Best Access Solutions, Inc., <http://www.bestaccess.com/index.php/products/behavioral-health-products/>
Bath, www.best-bath.com
Big John, www.bigjohntoiletseat.com
Blockhouse, www.blockhouse.com
Bradley, www.bradleycorp.com
Brey-Krause, www.breykrause.com
Britplas, www.britplas.com
Carnes, www.carnes.com
Carstens, www.carstens.com
Cascade, www.cascadesh.com
Ceco, www.cecodoor.com
CHG, www.chgbeds.com
Chloride, www.chloridesys.com/chloride
CompX, www.compx.com
Comfortex, www.comfortex.com
Cooper, www.cooperindustries.com
Cortech, www.cortechusa.com
CS Acrovyn, www.c-sgroup.com
Curries, www.curries.com
Custom Design Frameworks, www.customdesignframeworks.com
Dano Group, <http://www.danogroup.com>
Designplan, www.designplan.com
Dex-O-Tex, www.dexotex.com
DHSI, www.dhsi-seal.com

PLEASE NOTE:

Product information included in this document is intended for illustration of one or more specific items that are deemed appropriate for use in this type of facility. Comparable products by other manufacturers that meet the same design criteria may be substituted after careful comparison. No products are completely without risk. All product selections should be made in compliance with the findings of the comprehensive safety risk assessment for each location.

Door Control Services, www.doorcontrolsusa.com
Door Switch, <http://thedoorswitch.com>
Draper, Inc., www.draperinc.com
Dur-A-Flex, www.dur-a-flex.com
Dynalock Corp, www.dynalock.com
Eggrock, www.eggrock.com
Fence Factory, www.fencefactory.com
Filtrine Manufacturing Co.; www.filtrine.com
Flexco, www.flexcofloors.com/
Flxsigns, www.290signs.com
G-Tel, www.payphone.com/
Global, www.security-glazing.com
GoJo Industries, www.GOJO.com
Graham Wood Doors, www.grahamdoors.com
Grainger, www.grainger.com
Hafele, www.hafele.com/us/index.htm
Hager Companies, www.hagerco.com
Hospital Systems Inc., www.HospitalSystems.com
Hubbell, www.hubbell-wiring.com
IE; Blinds, www.ieblinds.com
Intersan, www.intersan.us
Ives, <http://us.allegion.com/>
J. L. Industries, www.jlindustries.com
Johnsonite, www.roppe.com
Kane Mfg., www.kanescreens.com
Kawneer Company, Inc., www.kawneer.com
Kees, www.kees.com
Kele, Inc., www.kele.com
Kenall, www.kenall.com
Kennon Products, www.suicideproofing.com
King Architectural Products, www.kingarchitecturalproducts.com
Kingsway Group USA www.kingswaygroupusa.com
Kirlin, www.kirlinlighting.com
Kwalu, www.kwalu.com
L. C. Doane, www.lcdoane.com
LCN, <http://us.allegion.com/brands/lcn/Pages/default.aspx>
Lamb Industries, www.e-switch.com
Lee's Carpet, www.leescarpets.com
Lonseal, <http://lonseal.com>
Luminaire, www.luminairelighting.com
Manko Windows, www.mankowindows.com
Maiman, www.maiman.com

PLEASE NOTE:

Product information included in this document is intended for illustration of one or more specific items that are deemed appropriate for use in this type of facility. Comparable products by other manufacturers that meet the same design criteria may be substituted after careful comparison. No products are completely without risk. All product selections should be made in compliance with the findings of the comprehensive safety risk assessment for each location.

Marathon, www.flexcofloors.com

Markar,

<https://www.assaabloydooraccessories.us/en/local/assaabloydooraccessoriesus/products/hinges/continuous-pin-barrel-hinges/behavioral-health-hinges/>

Marks USA, www.marksusa.com

Marshfield Door Systems, www.marshfielddoors.com

McMaster-Carr, www.mcmaster.com

Metalco, www.fence-system.com

Metrasans, <http://www.metrasens.com>

Mockett, Doug, www.mockett.com

Moduform, www.moduform.com

Modular Services, <http://headwalls.com>

National Gypsum, www.nationalgypsum.com

Nemschoff, www.nemschoff.com

Nora Systems, Inc.; www.nora.com/us

Norix, www.norix.com

Northwest Specialty Hardware. www.northwestsh.com

Norva Plastics, www.norvaplastics.com

Odd Ball, www.oddballindustries.com

O'Keeffe's, Inc., www.safti.com

Oldcastle, www.oldcastlebe.com

Pabco Gypsum, www.quietrock.com

Padded Surfaces, paddedsurfaces.com/CAD.html

Pecora, www.pecora.com

Peerless A-V, www.perlessmounts.com

Pineapple, www.pineapplecontracts.com

Pinpoint, www.pinpointinc.com

Quench; www.quenconline.com

Quick Drain USA, www.quickdrain.com

RAL & Associates, www.ieblinds.com

Rauland - Borg Corp., www.rauland.com

Re*cesso Lights, <http://recessolighting.com/>

Riverdale Mills, www.wirewall.com

ROA Contract Sales, www.rao.com

Rockwood, www.rockwoodmfg.com

Roppe, www.roppe.com

Sabic, www.sabic.com

SaftiFirst (O'Keeffe's, Inc.), www.safti.com

Sani-liner, www.wisconsinconverting.com

Sargent Lock, www.sargentlock.com

Schlage, <http://us.allegion.com>

PLEASE NOTE:

Product information included in this document is intended for illustration of one or more specific items that are deemed appropriate for use in this type of facility. Comparable products by other manufacturers that meet the same design criteria may be substituted after careful comparison. No products are completely without risk. All product selections should be made in compliance with the findings of the comprehensive safety risk assessment for each location.

Scotchshield, <http://solutions.3m.com/>
Securitech Group, Inc., www.securitech.com
Sheffield, www.sheffieldplastics.com
Sherwood Windows Group, www.sherwoodwindows.com
Sizewise, www.sizewise.net
Sloan, www.sloanvalve.com
Spec, www.specfurniture.com
Stanley Hardware, www.stanleyhardware.com
Stanley Security, www.stanleysecuritysolutions.com
Sto Americas, www.stocorp.com
Stryker, [/www.stryker.com/en-us/products/PatientHandlingEMSandEvacuationEquipment/index.htm](http://www.stryker.com/en-us/products/PatientHandlingEMSandEvacuationEquipment/index.htm)
Sugatsune, www.sugatsune.com
Surebond, www.surebond.com
Tamperproof Screws, www.tamperproof.com
This End Up, www.thisendup.com
3M, www.3m.com
Titus, www.titus-hvac.com
Top Knobs, www.myknobs.com
Total Door, www.total-door.com
Total Lock and Security, www.totallock.com
Townsteel, www.townsteel.com
Truebro, www.truebro.com/plumbing/truebro/lavshield
Truth Hdw., www.truth.com
TWA Comm, www.twacomm.com
2/90 Sign Systems, www.290signs.com
Tyco, www.tyco-fire.com
Unicel, www.unicelarchitectural.com/en/index.php
USG Sheetrock, www.usg.com/content/usgcom/en.html
Vistamatic, www.vistamaticvisionpanels.com/
Vocera, www.vocera.com
Wausau Windows, www.wausauwindow.com
Webb Shade, www.webbshade.com
Weizel Security, www.securingshospitals.com
Whitehall, www.whitehallmfg.com
Willoughby Industries, www.willoughby-ind.com
Zurn, www.zurn.com

PLEASE NOTE:

Product information included in this document is intended for illustration of one or more specific items that are deemed appropriate for use in this type of facility. Comparable products by other manufacturers that meet the same design criteria may be substituted after careful comparison. No products are completely without risk. All product selections should be made in compliance with the findings of the comprehensive safety risk assessment for each location.